

## Box Dimmer Dali

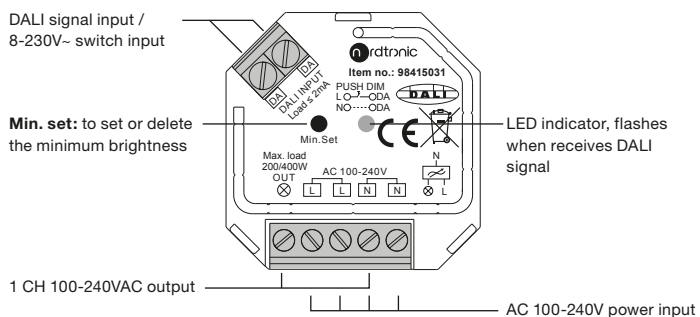

### Wiring diagram

#### 1. With DALI signal

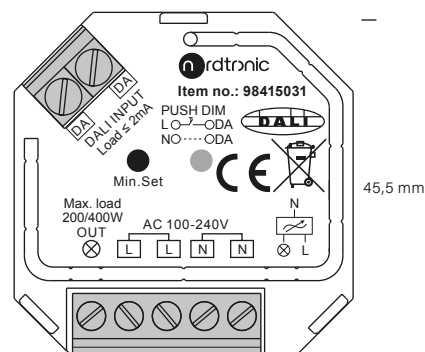
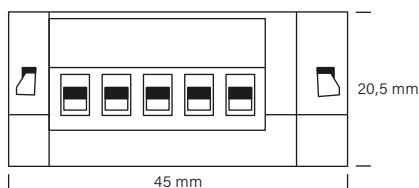
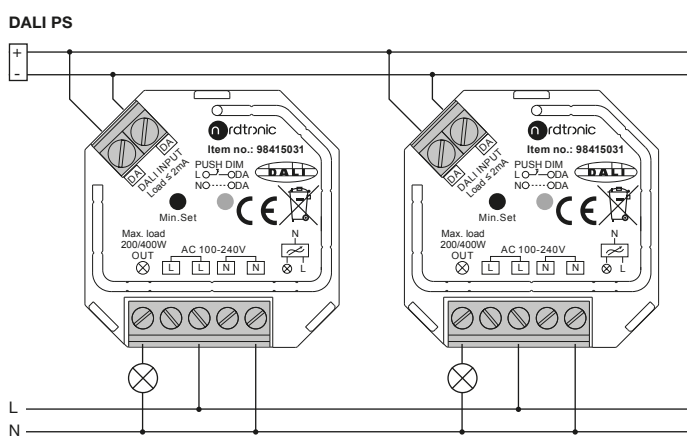

#### 2. With AC push switch

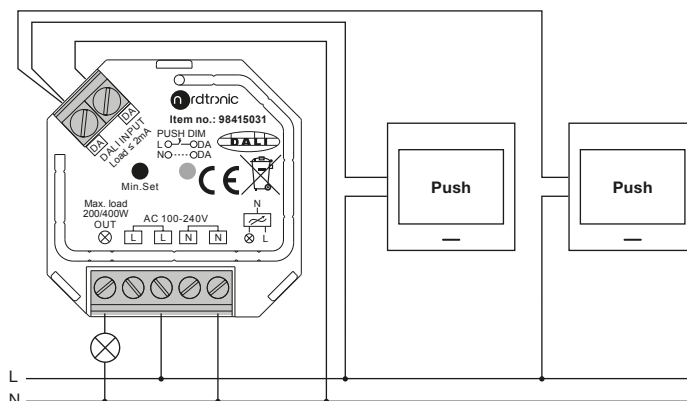

Input voltage	Output voltage	Output current	DALI Consumption	Max. thermal loss
100-240VAC	100-240VAC	Max. 1.5A	Max. 2mA	4W

Compatible load types			
Load symbol	Load type	Maximum load	Remarks
	Dimmable LED lamps	200W @ 220V 100W @ 110V	Due to variety of LED lamp designs, maximum number of LED lamps is further dependent on power factor result when connected to dimmer.
	Dimmable LED drivers	200W @ 220V 100W @ 110V	Maximum permitted number of drivers is 200W divided by driver nameplate power rating.
	Incandescent lighting, HV Halogen lamps	400W @ 220V 200W @ 110V	
	Low voltage halogen lighting with electronic transformers	200W @ 220V 100W @ 110V	

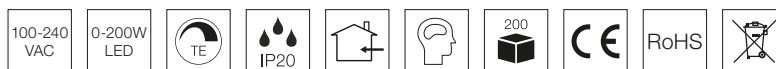

## Box Dimmer Dali

### 3. With push LV

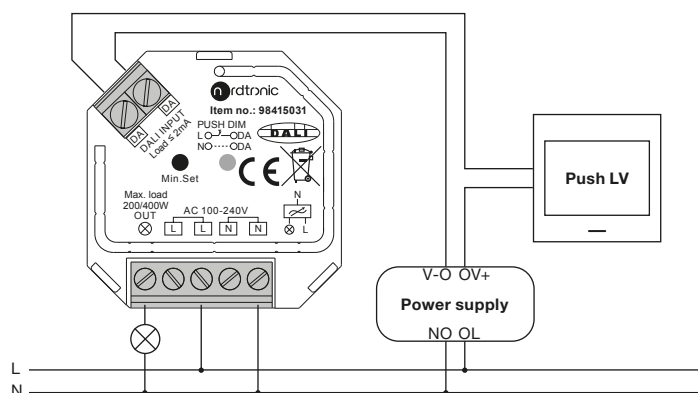

This phase dimmer adopts trailing edge dimming (reverse phase control), please make sure the connected loads support reverse phase control. Please refer to the user manual of the load or consult the supplier of the load.

### Operation

#### Setting DALI address

1 DALI addresses for 1 channel output is assigned by DALI Master controller automatically, please refer to user manuals of compatible DALI Masters for specific operations.

#### Setting minimum brightness:

Adjust brightness to a level, then press and hold down "Min. Set" key on the dimmer until the light flashes, once set a minimum brightness, the light can only be dimmable between this minimum brightness and maximum brightness.

The dimming range of this dimmer is 1%-100%, but some load types may flicker when dimmed to 1%, thus a minimum brightness shall be set higher than 1% to avoid flickering during dimming process.

#### Delete the minimum brightness:

Adjust the brightness to maximum level, then click "Min. Set" key on the dimmer to delete the minimum brightness, the light will flash to indicate successful reset.

#### Push dim:

While connected with PUSH switch, click the button to switch ON/OFF lights. Press and hold down the button to increase/decrease light intensity.

