

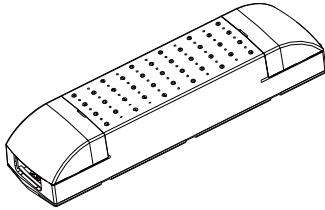

Art.-Nr.: 977.20
 977.25
 (+MA 197) PDG 10/16

CE UK CA

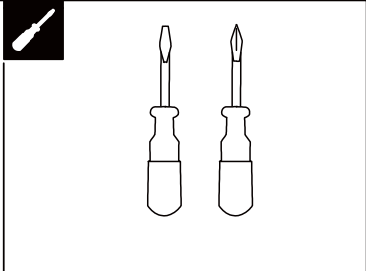
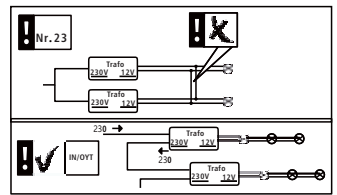
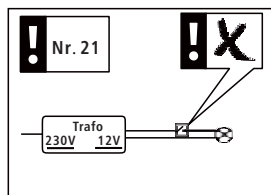
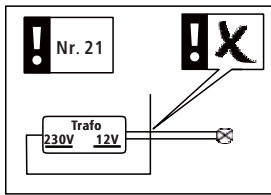
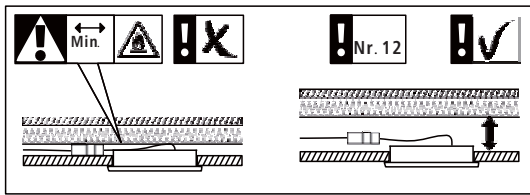
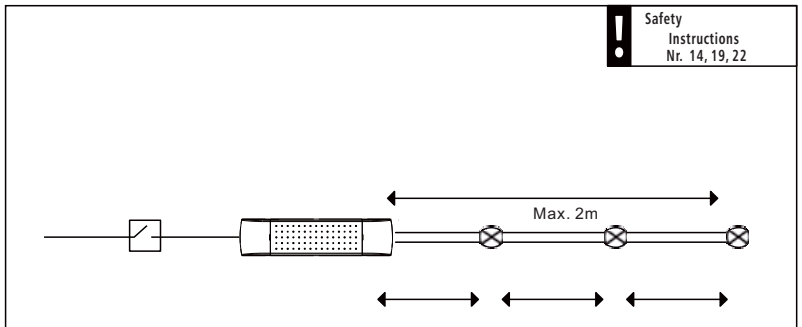
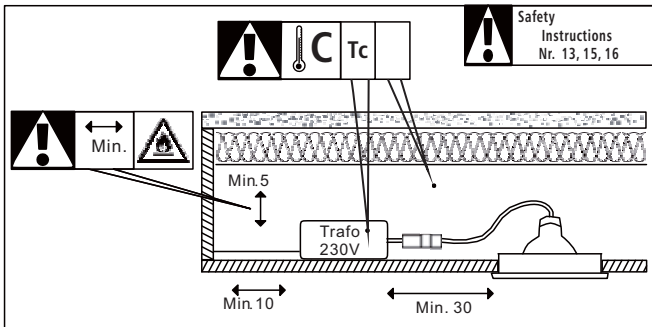
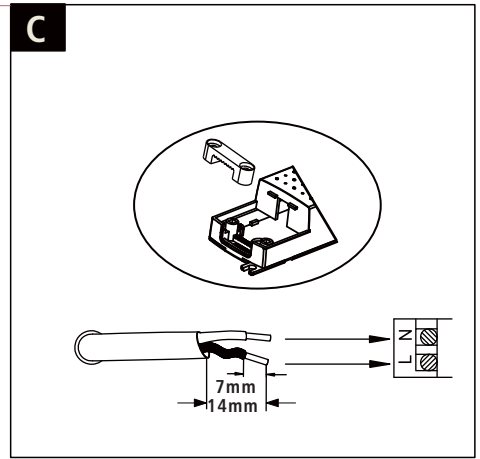
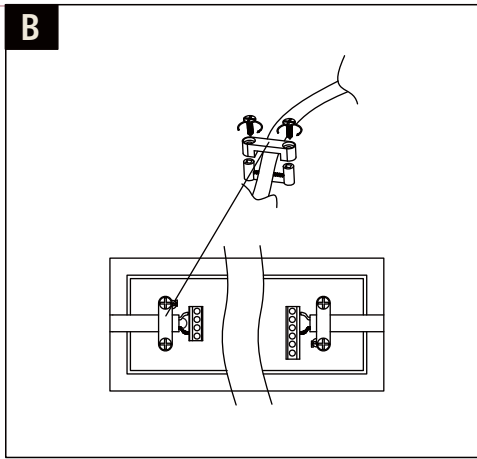
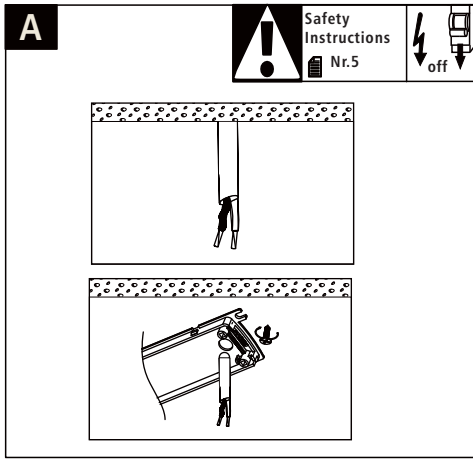

<p>Trafo 200/250VA Art.-Nr.: 977.20 977.25</p>		<p>Safety Instructions Nr. 28a/b</p>		<p>R, L, C</p>	<p>200VATC: +85°C 250VATC: +90°C</p>	<p>Ta -20 +50°C</p>	
<p>230V</p>	<p>12V</p>	<p>230V PRI</p> 	<p>14mm 7mm</p>	<p><input checked="" type="checkbox"/> H05VV-F2X1.5mm² <input checked="" type="checkbox"/> NYM3X2.5mm²</p>	<p>min. 2x0,75mm²</p>		
		<p>12V SEC</p> 	<p>14mm 7mm</p>	<p>min. 1.5mm²X6 or 2.5mm²X2</p>	<p>min. 2x 2,5mm²</p>		

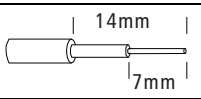
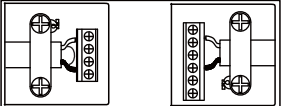
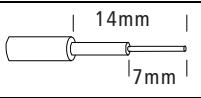
! -D Altgeräte dürfen nicht in den Restmüll. Sie können bei öffentlichen Sammelstellen von Entsorgungsträgern abgegeben werden. Altbatterien und Altkumulatoren, sowie Lampen, die zerstörungsfrei aus dem Altgerät entnommen werden können, sind vor der Abgabe an eine Erfassungsstelle von dem Altgerät zu trennen. Vertreiber sind im Rahmen von § 17 Absatz 1 und 2 ElektroG zur unentgeltlichen Rücknahme dieses Produktes verpflichtet. Endnutzer von Altgeräten müssen eigenverantwortlich für die Löschung personenbezogener Daten auf den zu entsorgenden Altgeräten sorgen.
 www.paulmann.com