

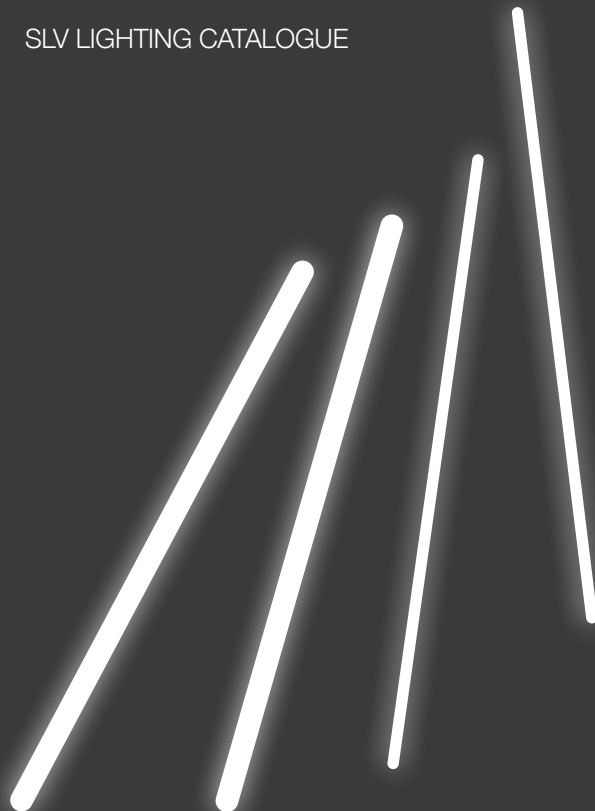

BIG WHITE[®] 2026

SLV LIGHTING CATALOGUE



PENDELLEUCHTEN



LED
QUIMERA | 187



SECKET
VARYT | 189
MIX
match



WUD | 191



SECKET
SUN | 192-195



SECKET
OLYPSO | 197

NEW



SECKET
MAGICO | 199



LED
NUMINOS® | 200-207



LED
GRIP! S | 209



LED
MEDO® RING | 210-211



LED
MEDO® PRO | 212-219



LED
MEDO® | 220-221



LED
SECKET
LALU® SET | 224-229



NEW



LED
ONE FLAT | 231



LED
ONE VERTICAL | 233



LED
ONE CUBE | 235



LED
ONE | 237-239



LED
ONE DOUBLE | 240



LED
ONE TRIPLE | 241



LED
ONE LINEAR | 243



SECKET
PANTILO ROPE | 245



SECKET
PANTILO OVAL | 247



SECKET
PANTILO | 247



SECKET
PANTILO CONVEX | 248-249



SECKET
LIGHT EYE® | 251



SECKET
ASTO TUBE | 253



LED
GLENOS® PRO | 255

NEW



LED
WORKLIGHT | 257



LED
WORKLIGHT PRO | 257



LED
PANEL 60 | 259

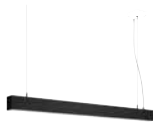

LED
GLENOS® | 261



LED
Q-LINE® | 263



LED
GRIP! FLAT | 265



LED
OCULUS | 266-267



SECKET
FITU | 269

MIX
match



SECKET
FENDA | 272-273

MIX
match



LED
HELIA | 276-277



SECKET
ENOLA® B | 279



SECKET
ENOLA® | 279



LED
ANELA | 279



SECKET
PARA CONE | 281



SECKET
PHELIA | 283



SECKET
FORCHINI | 284-285



SECKET
ROTOBALL | 287



SECKET
PARA DOME | 288



SECKET
PARA 380 | 289

1008033 187





QUIMERA PD, Phase

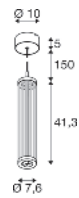

220-240 V ~50/60 Hz | 700 mA

Systemleistung: 8,5 W

Material: Aluminium/Glas



Indirect 330 lm | 2700 K 350 lm | 3000 K

Variante	Art.Nr.	EUR
● messing	1008033	369,00
● dunkel bronze	1008032	369,00
● dunkel kupfer	1008034	369,00

1008115+1008119 189





VARYT

PD, E14

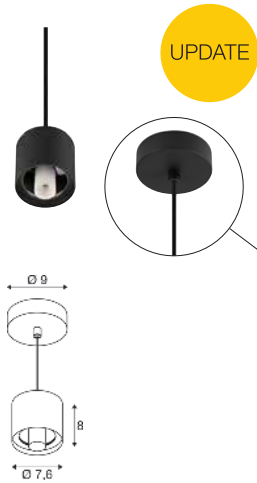

220-240 V ~50/60 Hz
Material: Aluminium



Socket: 1xE14 max. Ø: 11 cm | L: 3,8 cm

Variante	Art.Nr.	EUR
● schwarz	1008114	109,00
○ weiß	1008115	109,00
● messing	1008117	139,00
● chrom	1008116	119,00
● kupfer	1008118	139,00



E14 | 4 W | 320°
380 lm | 2700 K | EEK = F
5 kW/1000h

Art.Nr.: 1005284 6,50 EUR

VARYT

Glasschirm f. PD, WL, CL, TL



Ø: 12 cm
H: 13 cm
Material: Glas

Variante	Art.Nr.	EUR
○ weiß	1007859	69,00

VARYT

Glasschirm f. PD, WL, CL, TL



Ø: 11,5 cm
H: 13,5 cm
Material: Glas

Variante	Art.Nr.	EUR
○ weiß	1007860	75,00

VARYT

Glasschirm f. PD, WL, CL, TL



Ø: 12 cm
H: 12,7 cm
Material: Glas

Variante	Art.Nr.	EUR
● rauchgrau	1007858	79,00
● bernstein	1008023	79,00

VARYT

Glas Shade opal



Ø: 12 cm
H: 12,8 cm

Variante	Art.Nr.	EUR
○ weiß	1008119	59,00

1008045 191





WUD

PD, E27, half round

WUD

PD, E27, cylindrical

1008047 191

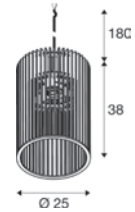

220-240 V ~50/60 Hz

- Naturmaterial
- offenes Kabelende
- Passendes Zubehör finden Sie auf Seite 271

220-240 V ~50/60 Hz

- Naturmaterial
- offenes Kabelende
- Passendes Zubehör finden Sie auf Seite 271

Variante	Art.Nr.	EUR
● natur	1008045	175,00

Variante	Art.Nr.	EUR
● natur	1008047	145,00



E27 | 7 W | 330°
650 lm | 2700 K | EEK = F
7 kWh/1000h



Art.Nr.: 1008157 49,00 EUR



E27 | 6 W | 330°
570 lm | 2200 K | EEK = F
6 kWh/1000h



Art.Nr.: 1008152 64,00 EUR



E27 | 7 W | 300°
640 lm | 2200-4000 K | EEK = G
7 kWh/1000h



Art.Nr.: 1010484 32,00 EUR

SUN 20
PD, E27



UPDATE

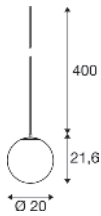

220-240 V ~50/60 Hz
Material: Aluminium

- offenes Kabelende
- Passendes Zubehör finden Sie auf Seite 271



Socket: 1xE27 max. Ø: 4,5 cm | L: 12 cm

Variante	Art.Nr.	EUR
● schwarz	1008139	99,00
● gold	1008138	99,00



E27 | 8 W | 240°
880 lm | 3000 K | EEK = E
8 kW/1000h



Art.Nr.: 1005289 10,25 EUR



1008139 192

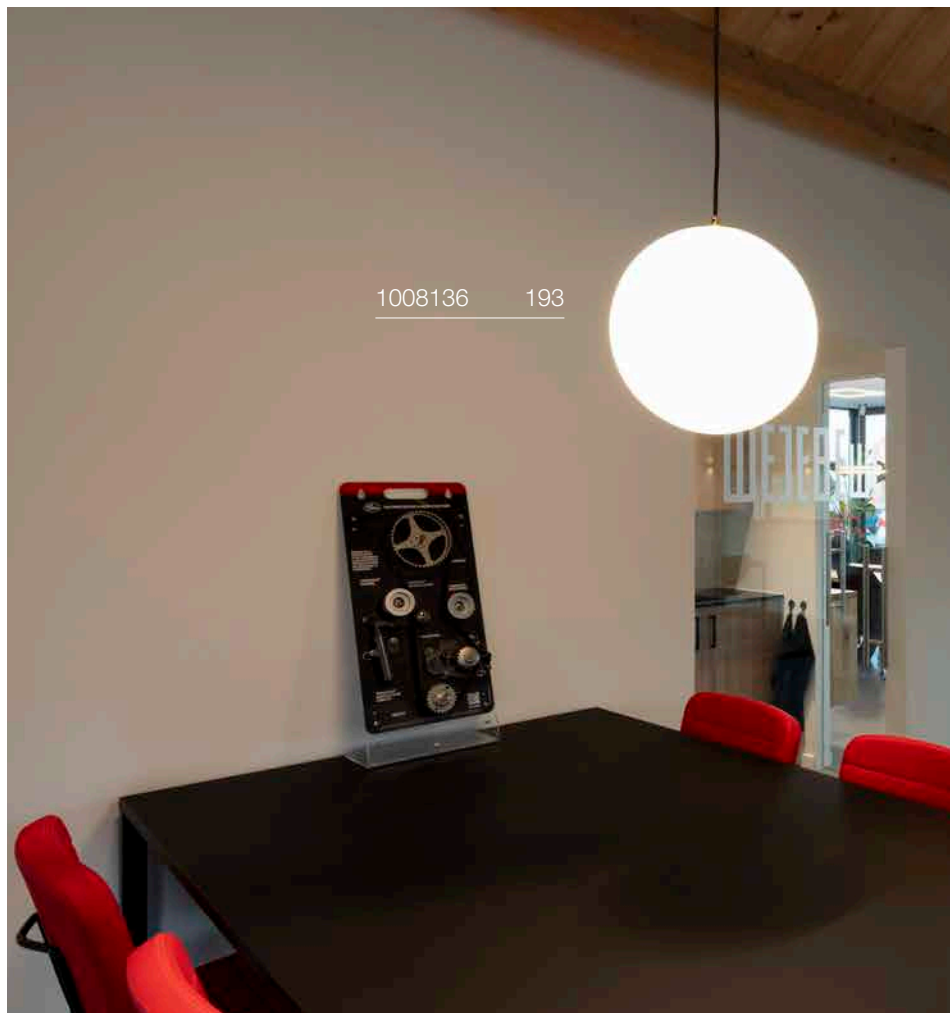

1008136 193



SUN 30
PD, E27



UPDATE

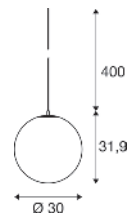

220-240 V ~50/60 Hz
Material: Aluminium

- offenes Kabelende
- Passendes Zubehör finden Sie auf Seite 271



Socket: 1xE27 max. Ø: 4,5 cm | L: 22 cm

Variante	Art.Nr.	EUR
● schwarz	1008137	149,00
● gold	1008136	149,00



E27 | 8 W | 240°
880 lm | 3000 K | EEK = E
8 kW/1000h



Art.Nr.: 1005289 10,25 EUR







SUN 40
PD, E27

UPDATE

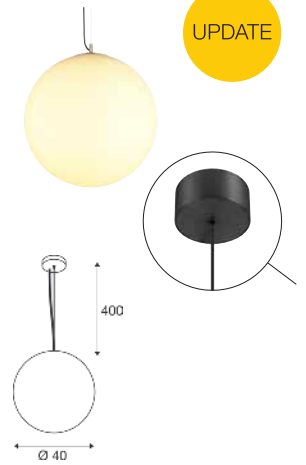

220-240 V ~50/60 Hz



Socket: 1xE27 max. Ø: 4,5 cm L: 22 cm

Variante	Art.Nr.	EUR
● schwarz	1008534	● 195,00
● gold	1008533	● 195,00



E27 | 14 W | 240°
1520 lm | 3000 K | EEK = E
14 kW/1000h



Art.Nr.: 1005307 12,50 EUR

1010416 197





OLYPSO 40 PD, E27

OLYPSO 50 PD, E27



220-240 V ~50/60 Hz
Material: Stahl



220-240 V ~50/60 Hz
Material: Stahl



Socket: 1xE27 max. Ø: 8 cm L: 12 cm

Variante	Art.Nr.	EUR
● schwarz	1010413	205,00
● gold	1010414	209,00



Socket: 1xE27 max. Ø: 12 cm L: 16 cm

Variante	Art.Nr.	EUR
● schwarz	1010415	255,00
● gold	1010416	259,00



E27 | 8 W | 240°
880 lm | 3000 K | EEK = E
8 kW/1000h



Art.Nr.: 1005289 10,25 EUR



E27 | 14 W | 240°
1520 lm | 3000 K | EEK = E
14 kW/1000h



Art.Nr.: 1005307 12,50 EUR



E27 | 9,5 W | 190°
1100 lm | 2200-6500 K | EEK = F
10 kWh/1000h



Art.Nr.: 1010465 35,00 EUR

1008502 + 1008504 + 1008506

199



1009135

199

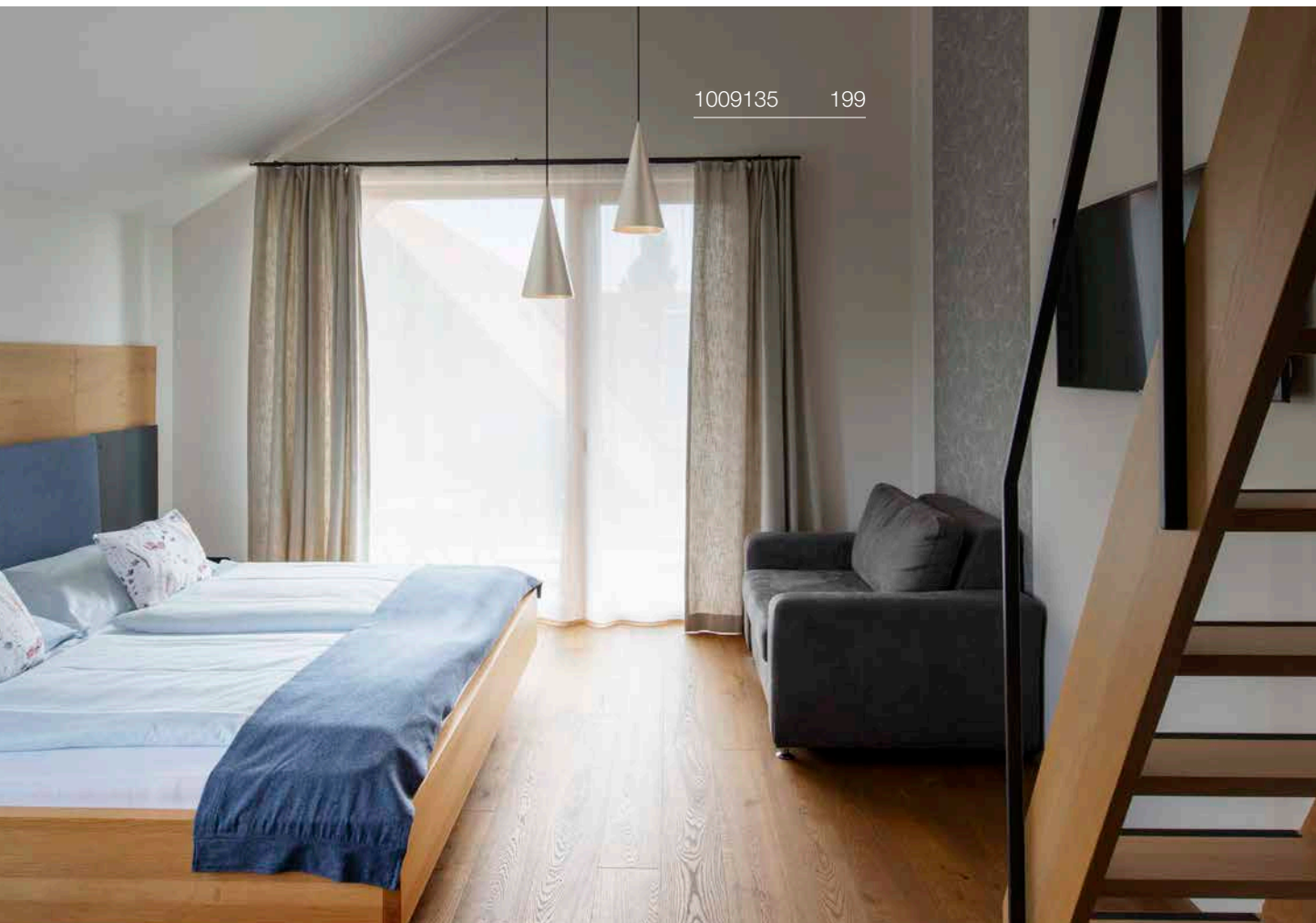



MAGICO 20 PD, E27

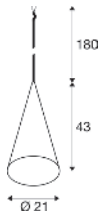

220-240 V ~50/60 Hz
Material: Aluminium

• Passendes Zubehör finden Sie auf Seite 271



Socket: 1xE27

Variante	Art.Nr.	EUR
● schwarz/gold	1008502	189,00
● schwarz	1008500	189,00
○ weiß	1008501	189,00
● aluminium	1009135	194,00



E27 | 8 W | 320°
700 lm | 2500 K | EEK = F
8 kWh/1000h

Art.Nr.: 1005265 26,50 EUR



E27 | 7 W | 300°
640 lm | 2200-4000 K | EEK = G
7 kWh/1000h

Art.Nr.: 1010484 32,00 EUR

MAGICO 38 PD, E27

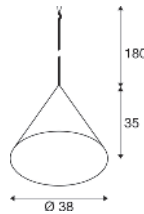

220-240 V ~50/60 Hz
Material: Aluminium

• Passendes Zubehör finden Sie auf Seite 271



Socket: 1xE27

Variante	Art.Nr.	EUR
● schwarz/gold	1008505	199,00
● schwarz	1008503	199,00
○ weiß	1008504	199,00
● aluminium	1009136	204,00



E27 | 8 W | 320°
700 lm | 2500 K | EEK = F
8 kWh/1000h

Art.Nr.: 1005265 26,50 EUR



E27 | 7 W | 300°
640 lm | 2200-4000 K | EEK = G
7 kWh/1000h

Art.Nr.: 1010484 32,00 EUR

MAGICO 55 PD, E27

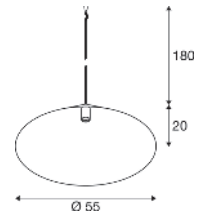

220-240 V ~50/60 Hz
Material: Aluminium

• Passendes Zubehör finden Sie auf Seite 271



Socket: 1xE27

Variante	Art.Nr.	EUR
● schwarz/gold	1008508	205,00
● schwarz	1008507	205,00
○ weiß	1008506	205,00
● aluminium	1009137	210,00



E27 | 8 W | 320°
700 lm | 2500 K | EEK = F
8 kWh/1000h

Art.Nr.: 1005265 26,50 EUR



E27 | 7 W | 300°
640 lm | 2200-4000 K | EEK = G
7 kWh/1000h

Art.Nr.: 1010484 32,00 EUR

NUMINOS® S

PD, PHASE

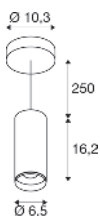

● schwarz



220-240 V ~50/60 Hz | 200 mA
 Systemleistung: 8 W
 Material: Aluminium

Variante	EUR
Alle S Varianten	140,00
Alle S DALI Varianten	198,00

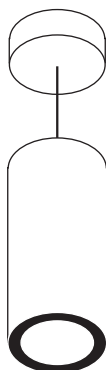

○ weiß

Hinweis:
 Zierring auch in weiß, gold
 und kupfer erhältlich



Artikel	Art.Nr.	EUR
Front Ring S		
○ weiß	1006167	1,30
● kupfer	1008140	8,00
● gold	1008144	8,00



					Art.Nr.	
	2700 K	950 lm	24°	16	1004146	
			36°	16	1004147	
			60°	19	1004148	
	3000 K	1050 lm	24°	16	1004154	
			36°	16	1004155	
			60°	19	1004156	
	4000 K	1100 lm	24°	16	1004162	
			36°	16	1004163	
			60°	19	1004164	
	2700 K	950 lm	24°	16	1004434	
			36°	16	1004435	
			60°	19	1004436	
	3000 K	1050 lm	24°	16	1004442	
			36°	16	1004443	
			60°	19	1004444	
	4000 K	1100 lm	24°	16	1004450	
			36°	16	1004451	
			60°	19	1004452	
	2700 K	950 lm	24°	16	1004150	
			36°	16	1004151	
			60°	19	1004152	
	3000 K	1050 lm	24°	16	1004158	
			36°	16	1004159	
			60°	19	1004160	
	4000 K	1100 lm	24°	16	1004166	
			36°	16	1004167	
			60°	19	1004168	
	2700 K	950 lm	24°	16	1004438	
			36°	16	1004439	
			60°	19	1004440	
	3000 K	1050 lm	24°	16	1004446	
			36°	16	1004447	
			60°	19	1004448	
	4000 K	1100 lm	24°	16	1004454	
			36°	16	1004455	
			60°	19	1004456	

NUMINOS® M

PD, PHASE

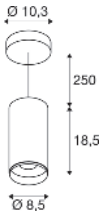

● schwarz



220-240 V ~50/60 Hz | 350 mA
 Systemleistung: 14 W
 Material: Aluminium/PC

Variante	EUR
Alle M Varianten	157,00
Alle M DALI Varianten	210,00

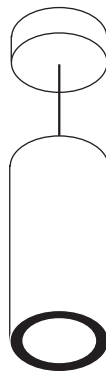

○ weiß

Hinweis:
 Zierring auch in weiß, gold
 und kupfer erhältlich



Artikel	Art.Nr.	EUR
Front Ring M		
○ weiß	1006168	2,40
● kupfer	1008141	9,00
● gold	1008145	9,00



					Art.Nr.	
	2700 K	1750 lm	24°	16	1004242	
			36°	16	1004243	
			60°	22	1004244	
	3000 K	1800 lm	24°	16	1004250	
			36°	16	1004251	
			60°	22	1004252	
	4000 K	1950 lm	24°	16	1004258	
			36°	16	1004259	
			60°	22	1004260	
	2700 K	1750 lm	24°	16	1004530	
			36°	16	1004531	
			60°	22	1004532	
	3000 K	1800 lm	24°	16	1004538	
			36°	16	1004539	
			60°	22	1004540	
	4000 K	1950 lm	24°	16	1004546	
			36°	16	1004547	
			60°	22	1004548	
	2700 K	1750 lm	24°	16	1004246	
			36°	16	1004247	
			60°	22	1004248	
	3000 K	1800 lm	24°	16	1004254	
			36°	16	1004255	
			60°	22	1004256	
	4000 K	1950 lm	24°	16	1004262	
			36°	16	1004263	
			60°	22	1004264	
	2700 K	1750 lm	24°	16	1004534	
			36°	16	1004535	
			60°	22	1004536	
	3000 K	1800 lm	24°	16	1004542	
			36°	16	1004543	
			60°	22	1004544	
	4000 K	1950 lm	24°	16	1004550	
			36°	16	1004551	
			60°	22	1004552	

NUMINOS® L

PD, PHASE

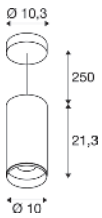

220-240 V ~50/60 Hz | 500 mA
 Systemleistung: 20 W
 Material: Aluminium/PC

Variante	EUR
Alle L Varianten	172,00
Alle L DALI Varianten	228,00

Hinweis:
 Zierring auch in weiß, gold
 und kupfer erhältlich



Artikel	Art.Nr.	EUR
Front Ring L		
○ weiß	1006169	2,40
● kupfer	1008142	10,00
● gold	1008146	10,00



● schwarz

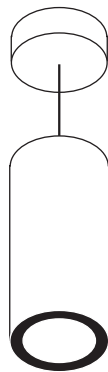

○ weiß



					Art.Nr.	
	2700 K	2300 lm	24°	16	1004338	
			36°	16	1004339	
			60°	19	1004340	
	3000 K	2400 lm	24°	16	1004346	
			36°	16	1004347	
			60°	19	1004348	
	4000 K	2600 lm	24°	16	1004354	
			36°	16	1004355	
			60°	19	1004356	
	2700 K	2300 lm	24°	16	1004626	
			36°	16	1004627	
			60°	19	1004628	
	3000 K	2400 lm	24°	16	1004634	
			36°	16	1004635	
			60°	19	1004636	
	4000 K	2600 lm	24°	16	1004642	
			36°	16	1004643	
			60°	19	1004644	
	2700 K	2300 lm	24°	16	1004342	
			36°	16	1004343	
			60°	19	1004344	
	3000 K	2400 lm	24°	16	1004350	
			36°	16	1004351	
			60°	19	1004352	
	4000 K	2600 lm	24°	16	1004358	
			36°	16	1004359	
			60°	19	1004360	
	2700 K	2300 lm	24°	16	1004630	
			36°	16	1004631	
			60°	19	1004632	
	3000 K	2400 lm	24°	16	1004638	
			36°	16	1004639	
			60°	19	1004640	
	4000 K	2600 lm	24°	16	1004646	
			36°	16	1004647	
			60°	19	1004648	

NUMINOS® XL

PD, DALI

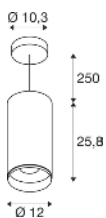

● schwarz



220-240 V ~50/60 Hz | 700 mA
 Systemleistung: 27 W
 Material: Aluminium/PC

Variante	EUR
Alle XL Varianten	198,00
Alle XL DALI Varianten	254,00

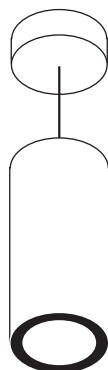

○ weiß

Hinweis:
 Zierring auch in weiß, gold
 und kupfer erhältlich



Artikel	Art.Nr.	EUR
Front Ring XL		
○ weiß	1006170	3,55
● kupfer	1008143	11,00
● gold	1008147	11,00



					Art.Nr.	
	2700 K	3550 lm	24°	16	1005777	
		3150 lm	36°	16	1005778	
		3150 lm	60°	22	1005779	
	3000 K	3550 lm	24°	16	1005783	
		3150 lm	36°	16	1005784	
		3150 lm	60°	22	1005785	
4000 K	3900 lm	24°	16	1005789		
	3500 lm	36°	16	1005790		
			60°	22	1005791	
	2700 K	3550 lm	24°	16	1005705	
		3150 lm	36°	16	1005706	
		3150 lm	60°	22	1005707	
	3000 K	3550 lm	24°	16	1005711	
		3150 lm	36°	16	1005712	
		3150 lm	60°	22	1005713	
4000 K	3900 lm	24°	16	1005717		
	3500 lm	36°	16	1005718		
			60°	22	1005719	
	2700 K	3550 lm	24°	16	1005780	
		3150 lm	36°	16	1005781	
		3150 lm	60°	22	1005782	
	3000 K	3550 lm	24°	16	1005786	
		3150 lm	36°	16	1005787	
		3150 lm	60°	22	1005788	
4000 K	3900 lm	24°	16	1005792		
	3500 lm	36°	16	1005793		
			60°	22	1005794	
	2700 K	3550 lm	24°	16	1005708	
		3150 lm	36°	16	1005709	
		3150 lm	60°	22	1005710	
	3000 K	3550 lm	24°	16	1005714	
		3150 lm	36°	16	1005715	
		3150 lm	60°	22	1005716	
4000 K	3900 lm	24°	16	1005720		
	3500 lm	36°	16	1005721		
			60°	22	1005722	



1009066 209



GRIP! S

PD, PHASE, Ø 3 cm

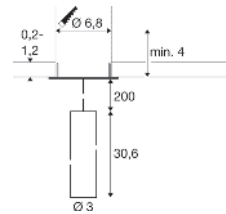

220-240 V ~50/60 Hz | 250 mA

Systemleistung: 10 W

Material: Stahl

- Inklusive Honeycomb-Zubehör



590 lm | 2700 K | 620 lm | 3000 K

Variante	Art.Nr.	EUR
● weiß/schwarz 2700 K	1009060	159,00
● weiß/schwarz 3000 K	1009061	159,00
● schwarz/gold 2700 K	1009062	159,00
● schwarz/gold 3000 K	1009063	159,00
● bronze/schwarz 2700 K	1009064	159,00
● bronze/schwarz 3000 K	1009065	159,00
● gold/schwarz 2700 K	1009066	159,00
● gold/schwarz 3000 K	1009067	159,00



Artikel	Art.Nr.	EUR
GRIP! S Dekoring		
○ weiß	1008488	18,00
● schwarz	1008489	18,00
● nickel	1008490	18,00
● gold	1008491	18,00



1008590 210

MEDO® RING 60 PD, DALI



220-240 V ~50/60 Hz | 700 mA

Systemleistung: 26 W

Material: Aluminium/Stahl

- BEG förderfähig



Down 3750 lm | 3000 K | 4000 lm | 4000 K

Variante	Art.Nr.	EUR
● schwarz	1008589	779,00
○ weiß	1008590	779,00



MEDO® RING 60 PD, PHASE



220-240 V ~50/60 Hz | 700 mA
Systemleistung: 27 W
Material: Aluminium/Stahl

- BEG förderfähig



Down 3750 lm | 3000 K | 4000 lm | 4000 K

Variante	Art.Nr.	EUR
● schwarz	1008591	749,00
○ weiß	1008592	749,00

MEDO® RING 90 PD, DALI



220-240 V ~50/60 Hz | 1200 mA
Systemleistung: 42 W
Material: Aluminium/Stahl



Down 5000 lm | 3000 K | 5300 lm | 4000 K

Variante	Art.Nr.	EUR
● schwarz	1008593	975,00
○ weiß	1008594	975,00

MEDO® RING 90 PD, PHASE

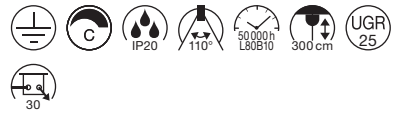
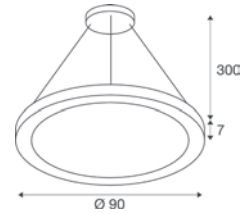

220-240 V ~50/60 Hz | 1200 mA
Systemleistung: 43 W
Material: Aluminium/Stahl



Down 5000 lm | 3000 K | 5300 lm | 4000 K

Variante	Art.Nr.	EUR
● schwarz	1008595	939,00
○ weiß	1008596	939,00

MEDO® PRO 30

CW, DALI, UGR<19



220-240 V ~50/60 Hz | 250 mA
Systemleistung: 10 W
Material: Aluminium/Stahl

- BEG förderfähig



Direct	1150 lm	3000 K	1150 lm	4000 K
Indirect	100 lm		100 lm	

Variante	Art.Nr.	EUR
● schwarz	1007284	329,00
○ weiß	1007285	329,00



Artikel	Art.Nr.	EUR
Abhängeset 1,5m		
● schwarz	135250	44,75
○ weiß	135251	44,75
Abhängeset 5m		
○ weiß	1001950	99,00
● schwarz	1001952	99,00

MEDO® PRO 30

CW, PHASE, UGR<19



220-240 V ~50/60 Hz | 250 mA
Systemleistung: 10 W
Material: Aluminium/Stahl

- BEG förderfähig



Direct	1150 lm	3000 K	1150 lm	4000 K
Indirect	100 lm		100 lm	

Variante	Art.Nr.	EUR
● schwarz	1007288	299,00
○ weiß	1007289	299,00



Artikel	Art.Nr.	EUR
Abhängeset 1,5m		
● schwarz	135250	44,75
○ weiß	135251	44,75
Abhängeset 5m		
○ weiß	1001950	99,00
● schwarz	1001952	99,00

1007284 212

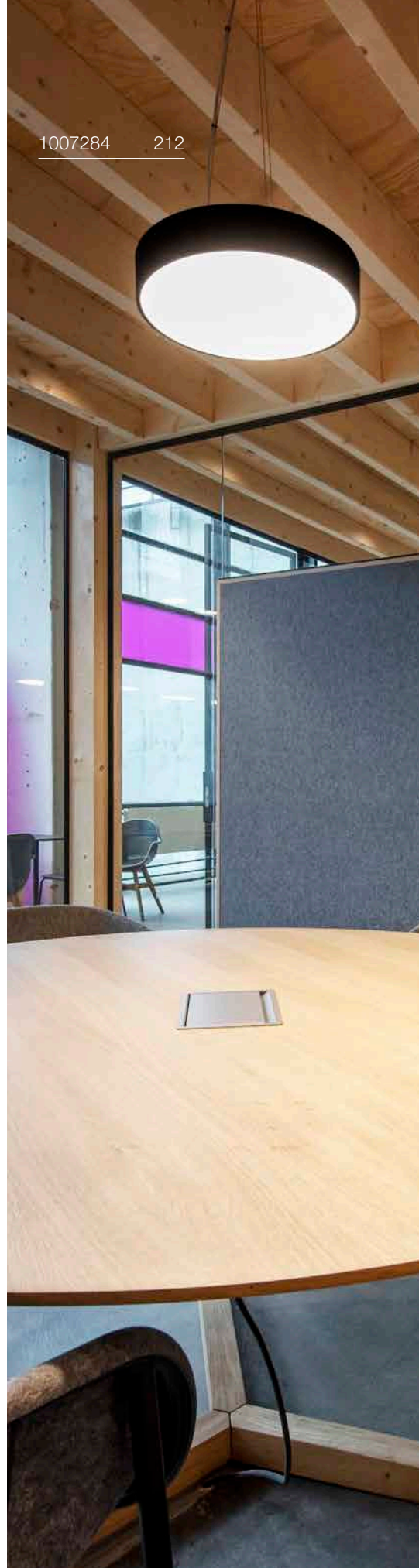



MEDO® PRO 40 CW, DALI, UGR<19

MEDO® PRO 40 CW, PHASE, UGR<19

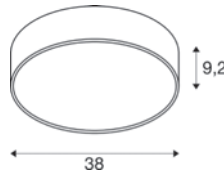

220-240 V ~50/60 Hz | 500 mA
Systemleistung: 19 W
Material: Aluminium/Stahl

- BEG förderfähig



Direct	2200 lm	3000 K	2300 lm	4000 K
Indirect	200 lm		200 lm	

Variante	Art.Nr.	EUR
● schwarz	1007292	399,00
○ weiß	1007293	399,00



Artikel	Art.Nr.	EUR
Abhängeset 1,5m		
● schwarz	135250	44,75
○ weiß	135251	44,75
Abhängeset 5m		
○ weiß	1001950	99,00
● schwarz	1001952	99,00

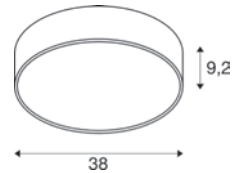

220-240 V ~50/60 Hz | 500 mA
Systemleistung: 19 W
Material: Aluminium/Stahl

- BEG förderfähig



Direct	2200 lm	3000 K	2300 lm	4000 K
Indirect	200 lm		200 lm	

Variante	Art.Nr.	EUR
● schwarz	1007296	349,00
○ weiß	1007297	349,00



Artikel	Art.Nr.	EUR
Abhängeset 1,5m		
● schwarz	135250	44,75
○ weiß	135251	44,75
Abhängeset 5m		
○ weiß	1001950	99,00
● schwarz	1001952	99,00

MEDO® PRO 60
CW, DALI, UGR<19

MEDO® PRO 60
CW, PHASE, UGR<19

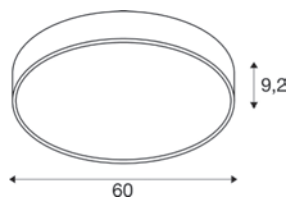

220-240 V ~0/50/60 Hz | 1000 mA
Systemleistung: 39 W
Material: Aluminium/Stahl

- BEG förderfähig



Direct	4600 lm	3000 K	4700 lm	4000 K
Indirect	400 lm		400 lm	

Variante	Art.Nr.	EUR
● schwarz	1007300	699,00
○ weiß	1007301	699,00



Artikel	Art.Nr.	EUR
Abhängeset 1,5m		
● schwarz	135250	44,75
○ weiß	135251	44,75
Abhängeset 5m		
○ weiß	1001950	99,00
● schwarz	1001952	99,00

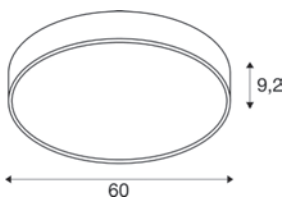

220-240 V ~50/60 Hz | 1000 mA
Systemleistung: 37 W
Material: Aluminium/Stahl

- BEG förderfähig



Direct	4600 lm	3000 K	4700 lm	4000 K
Indirect	400 lm		400 lm	

Variante	Art.Nr.	EUR
● schwarz	1007304	629,00
○ weiß	1007305	629,00



Artikel	Art.Nr.	EUR
Abhängeset 1,5m		
● schwarz	135250	44,75
○ weiß	135251	44,75
Abhängeset 5m		
○ weiß	1001950	99,00
● schwarz	1001952	99,00



1007304 214



1007308 215



MEDO® PRO 90 CL, DALI, UGR<19



220-240 V ~50/60 Hz | 1000 mA
Systemleistung: 75 W
Material: Aluminium/Stahl

- BEG förderfähig



Direct	8800 lm	3000 K	9100 lm	4000 K
Indirect	600 lm		600 lm	

Variante	Art.Nr.	EUR
● schwarz	1007308	1.399,00
○ weiß	1007309	1.399,00

Artikel	Art.Nr.	EUR
Abhängeset 1,5m		
● schwarz	135250	44,75
○ weiß	135251	44,75
Abhängeset 5m		
○ weiß	1001950	99,00
● schwarz	1001952	99,00

MEDO® PRO 90 CL, PHASE, UGR<19



220-240 V ~50/60 Hz | 1000 mA
Systemleistung: 74 W
Material: Aluminium/Stahl

- BEG förderfähig



Direct	8800 lm	3000 K	9100 lm	4000 K
Indirect	600 lm		600 lm	

Variante	Art.Nr.	EUR
● schwarz	1007312	1.249,00
○ weiß	1007313	1.249,00

Artikel	Art.Nr.	EUR
Abhängeset 1,5m		
● schwarz	135250	44,75
○ weiß	135251	44,75
Abhängeset 5m		
○ weiß	1001950	99,00
● schwarz	1001952	99,00

MEDO® PRO 30

CW, DALI

MEDO® PRO 30

CW, PHASE

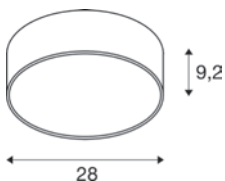
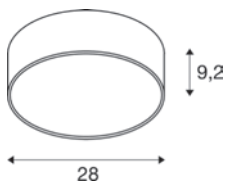

220-240 V ~50/60 Hz | 250 mA
Systemleistung: 10 W
Material: Aluminium/Stahl

- BEG förderfähig



Direct	1300 lm	3000 K	1300 lm	4000 K
Indirect	50 lm		50 lm	

Variante	Art.Nr.	EUR
● schwarz	1007286	319,00
○ weiß	1007287	319,00



Artikel	Art.Nr.	EUR
Abhängeset 1,5m		
● schwarz	135250	44,75
○ weiß	135251	44,75
Abhängeset 5m		
○ weiß	1001950	99,00
● schwarz	1001952	99,00



220-240 V ~50/60 Hz | 250 mA
Systemleistung: 10 W
Material: Aluminium/Stahl

- BEG förderfähig



Direct	1300 lm	3000 K	1300 lm	4000 K
Indirect	50 lm		50 lm	

Variante	Art.Nr.	EUR
● schwarz	1007290	289,00
○ weiß	1007291	289,00



Artikel	Art.Nr.	EUR
Abhängeset 1,5m		
● schwarz	135250	44,75
○ weiß	135251	44,75
Abhängeset 5m		
○ weiß	1001950	99,00
● schwarz	1001952	99,00

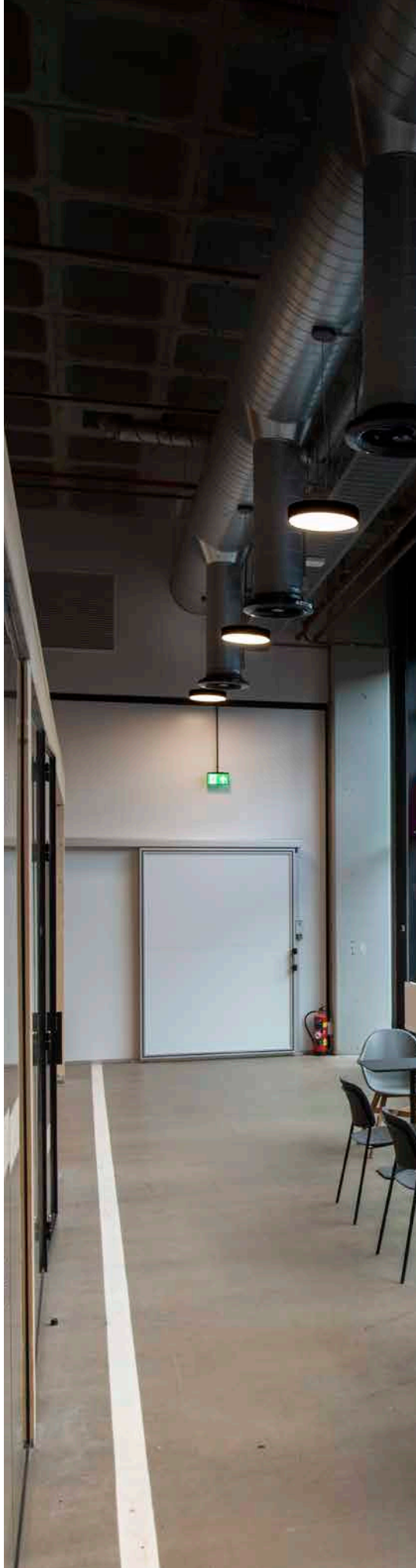



1007294 217



MEDO® PRO 40 CW, DALI

MEDO® PRO 40 CW, PHASE

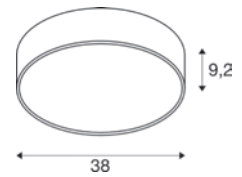
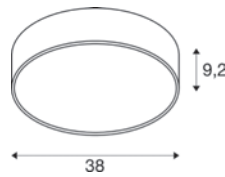

220-240 V ~50/60 Hz | 500 mA
Systemleistung: 19 W
Material: Aluminium/Stahl

220-240 V ~50/60 Hz | 500 mA
Systemleistung: 19 W
Material: Aluminium/Stahl

• BEG förderfähig

• BEG förderfähig



Direct	2550 lm	3000 K	2550 lm	4000 K
Indirect	100 lm		100 lm	

Direct	2550 lm	3000 K	2550 lm	4000 K
Indirect	100 lm		100 lm	

Variante	Art.Nr.	EUR
● schwarz	1007294	389,00
○ weiß	1007295	389,00

Variante	Art.Nr.	EUR
● schwarz	1007298	339,00
○ weiß	1007299	339,00



Artikel	Art.Nr.	EUR
Abhängeset 1,5m		
● schwarz	135250	44,75
○ weiß	135251	44,75
Abhängeset 5m		
○ weiß	1001950	99,00
● schwarz	1001952	99,00

Artikel	Art.Nr.	EUR
Abhängeset 1,5m		
● schwarz	135250	44,75
○ weiß	135251	44,75
Abhängeset 5m		
○ weiß	1001950	99,00
● schwarz	1001952	99,00

MEDO® PRO 60
CW, DALI

MEDO® PRO 60
CW, PHASE

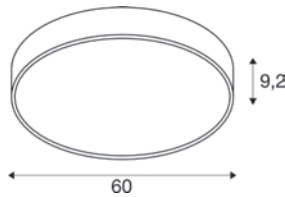
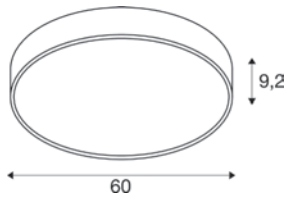

220-240 V ~0/50/60 Hz | 1000 mA
Systemleistung: 39 W
Material: Aluminium/Stahl

• BEG förderfähig

220-240 V ~50/60 Hz | 1000 mA
Systemleistung: 37 W
Material: Aluminium/Stahl

• BEG förderfähig



Direct	5250 lm	3000 K	5300 lm	4000 K
Indirect	200 lm		200 lm	

Variante	Art.Nr.	EUR
● schwarz	1007302	679,00
○ weiß	1007303	679,00



Artikel	Art.Nr.	EUR
Abhängeset 1,5m		
● schwarz	135250	44,75
○ weiß	135251	44,75
Abhängeset 5m		
○ weiß	1001950	99,00
● schwarz	1001952	99,00



Direct	5250 lm	3000 K	5300 lm	4000 K
Indirect	200 lm		200 lm	

Variante	Art.Nr.	EUR
● schwarz	1007306	609,00
○ weiß	1007307	609,00



Artikel	Art.Nr.	EUR
Abhängeset 1,5m		
● schwarz	135250	44,75
○ weiß	135251	44,75
Abhängeset 5m		
○ weiß	1001950	99,00
● schwarz	1001952	99,00



1007303

218



MEDO® PRO 90 CL, DALI

MEDO® PRO 90 CL, PHASE



220-240 V ~50/60 Hz | 1000 mA
Systemleistung: 75 W
Material: Aluminium/Stahl

220-240 V ~50/60 Hz | 1000 mA
Systemleistung: 74 W
Material: Aluminium/Stahl

• BEG förderfähig

• BEG förderfähig



Direct	10550 lm	3000 K	10750 lm	4000 K
Indirect	450 lm		450 lm	

Direct	10550 lm	3000 K	10750 lm	4000 K
Indirect	450 lm		450 lm	

Variante	Art.Nr.	EUR
● schwarz	1007310	1.379,00
○ weiß	1007311	1.379,00

Variante	Art.Nr.	EUR
● schwarz	1007314	1.229,00
○ weiß	1007315	1.229,00



Artikel	Art.Nr.	EUR
Abhängeset 1,5m		
● schwarz	135250	44,75
○ weiß	135251	44,75
Abhängeset 5m		
○ weiß	1001950	99,00
● schwarz	1001952	99,00

Artikel	Art.Nr.	EUR
Abhängeset 1,5m		
● schwarz	135250	44,75
○ weiß	135251	44,75
Abhängeset 5m		
○ weiß	1001950	99,00
● schwarz	1001952	99,00

MEDO® 30
CW, PHASE



220-240 V ~50/60 Hz | 250 mA
Systemleistung: 12 W
Material: Aluminium/Stahl



1000 lm | 2700 K | 1050 lm | 3000 K | 1150 lm | 4000 K
50 lm | 50 lm | 50 lm

Variante	Art.Nr.	EUR
● schwarz	1007316	249,00
○ weiß	1007317	249,00
● grau	1007318	249,00



Artikel	Art.Nr.	EUR
Abhängeset 1,5m		
● schwarz	135250	44,75
○ weiß	135251	44,75
Abhängeset 5m		
○ weiß	1001950	99,00
● schwarz	1001952	99,00

MEDO® 40
CW, PHASE



220-240 V ~50/60 Hz | 500 mA
Systemleistung: 20 W
Material: Aluminium/Stahl



2000 lm | 2700 K | 2100 lm | 3000 K | 2250 lm | 4000 K
100 lm | 100 lm | 100 lm

Variante	Art.Nr.	EUR
● schwarz	1007319	279,00
○ weiß	1007320	279,00
● grau	1007321	279,00



Artikel	Art.Nr.	EUR
Abhängeset 1,5m		
● schwarz	135250	44,75
○ weiß	135251	44,75
Abhängeset 5m		
○ weiß	1001950	99,00
● schwarz	1001952	99,00

1007323 221

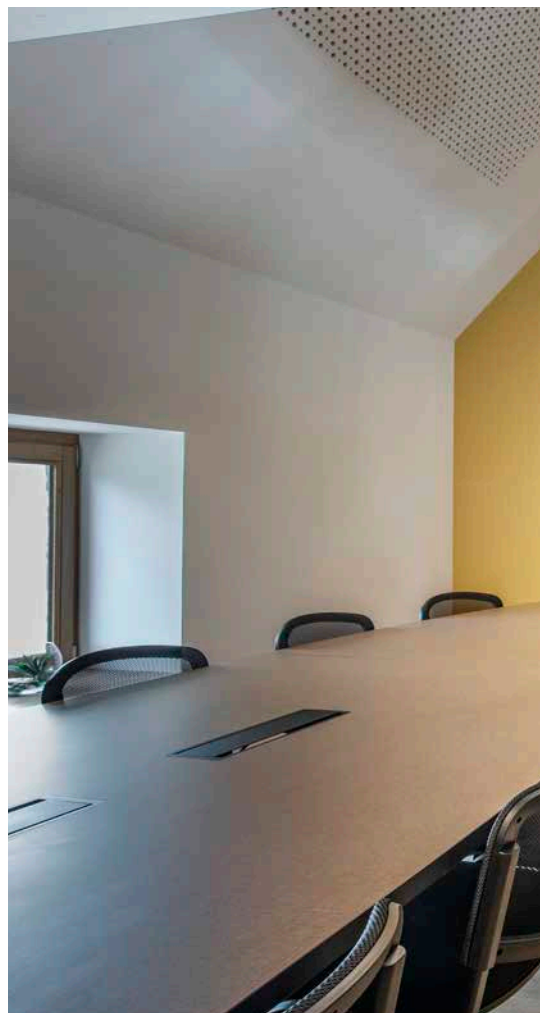



MEDO® 60 CW, PHASE

MEDO® 90 CL, PHASE

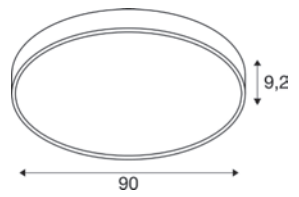
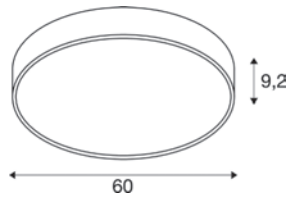

220-240 V ~50/60 Hz | 1000 mA
Systemleistung: 39 W
Material: Aluminium/Stahl

220-240 V ~50/60 Hz | 1000 mA
Systemleistung: 79 W
Material: Aluminium/Stahl



3850 lm	2700 K	4050 lm	3000 K	4300 lm	4000 K
200 lm		200 lm		200 lm	

Variante	Art.Nr.	EUR
● schwarz	1007322	529,00
○ weiß	1007323	529,00
● grau	1007324	529,00



Artikel	Art.Nr.	EUR
Abhängeset 1,5m		
● schwarz	135250	44,75
○ weiß	135251	44,75
Abhängeset 5m		
○ weiß	1001950	99,00
● schwarz	1001952	99,00



8000 lm	2700 K	8400 lm	3000 K	9000 lm	4000 K
300 lm		300 lm		300 lm	

Variante	Art.Nr.	EUR
● schwarz	1007325	1.049,00
○ weiß	1007326	1.049,00
● grau	1007327	1.049,00



Artikel	Art.Nr.	EUR
Abhängeset 1,5m		
● schwarz	135250	44,75
○ weiß	135251	44,75
Abhängeset 5m		
○ weiß	1001950	99,00
● schwarz	1001952	99,00

MEDO®

ÜBERSICHT

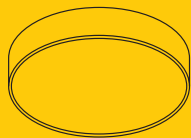

MEDO®
CW

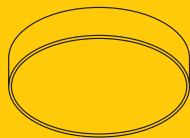

MEDO® PRO
CW

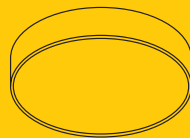

MEDO® PRO
CW

Größen	30 40 60 90	30 40 60 90	30 40 60 90
UGR	22 25	19 25	19 25
Steuerung	Phase	Phase	DALI 2
DC	-	-	✓
CCT Switch	2700K 3000K 4000K	3000K 4000K	3000K 4000K
EasyBase	✓	✓	✓
BEG-Förderung	-	✓	✓
Abhängeset	1,5 5 m (exkl.)	1,5 5 m (exkl.)	1,5 5 m (exkl.)

- Schnellere Installation dank EasyBase
- Förderfähige Effizienz ab 120 lm/W
- Dank prismatischer Optik auch geeignet für anspruchsvolle Arbeitsplätze (z.B. Büro- und Unterrichtsräume)

LED-Treiber sind nicht inkludiert und separat erhältlich

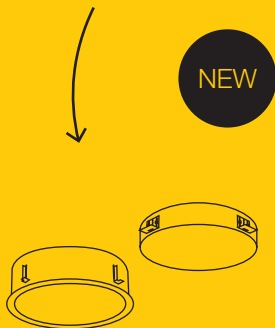

MEDO®
RL, RAHMENLOS |
EINBAURAHMEN



MEDO® RING
PD

30 40 60 90	60 90
19	25
*	Phase DALI 2
*	- ✓
3000K 4000K	3000K 4000K
-	-
✓	✓
-	3 m (inkl.)

*Treiberabhängig



DECKENLEUCHTEN

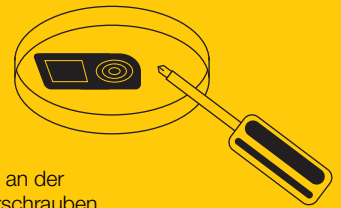

EasyBase an der Decke verschrauben

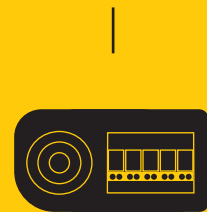

EasyBase verdrahten

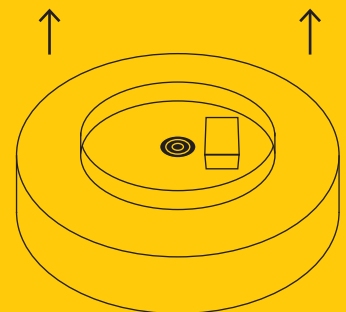

Via CCT-Switch Farbtemperatur wählen und die Leuchte einrasten, dabei auf die grünen Markierungen achten

MEDO® 60 und MEDO® 90 werden zusätzlich mit der vorhandenen Sicherungskette befestigt

LALU® SET

PD, E27 Base

UPDATE

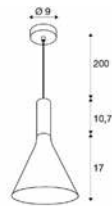

1010787 225



220-240 V ~50/60 Hz
Material: Aluminium/Stahl

- inkl. E27 Leuchtmittel



Socket: 1xE27

Variante	Art.Nr.	EUR
● schwarz	1010785	● 161,50





LALU® SET
PD, E27 Base



220-240 V ~50/60 Hz
Material: Aluminium/Stahl

- inkl. E27 Leuchtmittel



Socket: 1xE27

Variante	Art.Nr.	EUR
● schwarz	1010786 ●	202,60

LALU® SET
PD, E27 Base



220-240 V ~50/60 Hz
Material: Aluminium/Stahl

- inkl. E27 Leuchtmittel



Socket: 1xE27

Variante	Art.Nr.	EUR
● schwarz	1010787 ●	234,50

LALU® SET
PD, E27 Base



220-240 V ~50/60 Hz
Material: Aluminium/Stahl

- inkl. E27 Leuchtmittel



Socket: 1xE27

Variante	Art.Nr.	EUR
● schwarz	1010788 ●	200,50

Entdecken Sie
weitere Farben und
Formen der LALU®
auf auf KS-Licht.de

LALU® SET
PD, LED Base, Phase

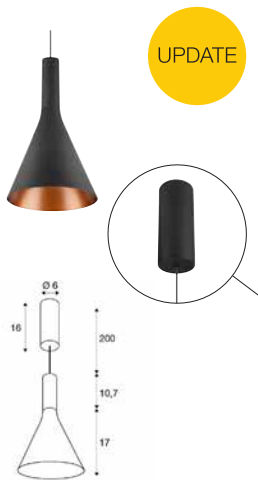

UPDATE



220-240 V ~50/60 Hz | 500 mA
Systemleistung: 9,5 W
Material: Aluminium/Stahl

- inklusive Farbtemperaturschalter
2700K/3000K



Down 550 lm|2700 K | 600 lm|3000 K

Variante	Art.Nr.	EUR
● schwarz	1010789	● 264,40

LALU® SET
PD, LED Base, Phase

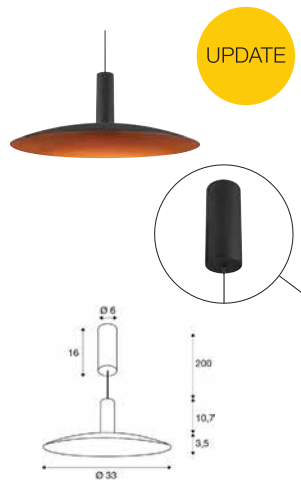

UPDATE



220-240 V ~50/60 Hz | 500 mA
Systemleistung: 9,5 W
Material: Aluminium/Stahl

- inklusive Farbtemperaturschalter
2700K/3000K



Down 650 lm|2700 K | 700 lm|3000 K

Variante	Art.Nr.	EUR
● schwarz	1010790	● 270,20

1010790 226

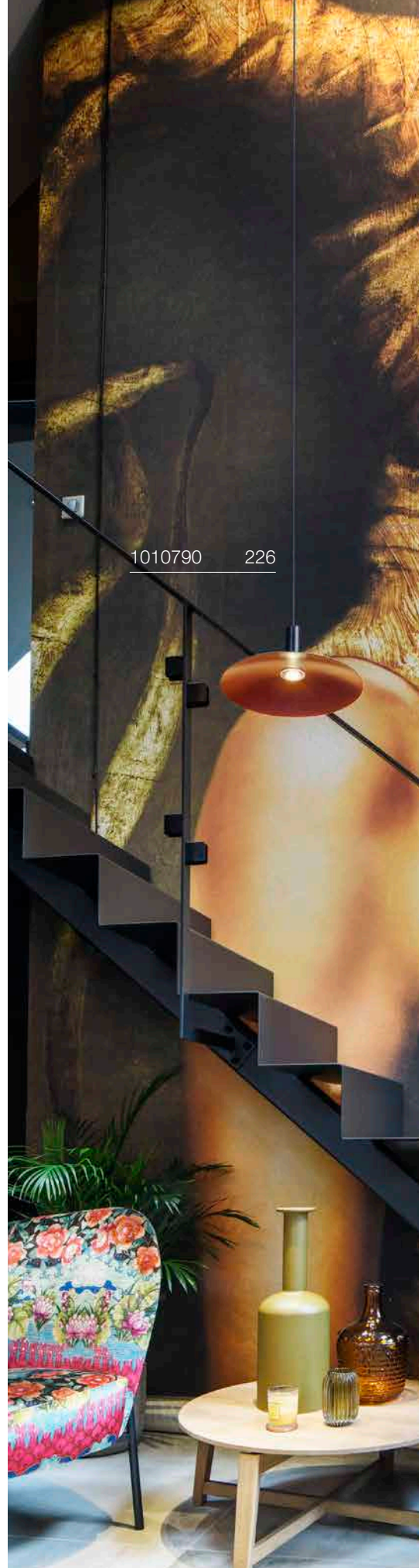



LALU® SET

PD, LED Base, Phase

LALU® SET

PD, LED Base, Phase

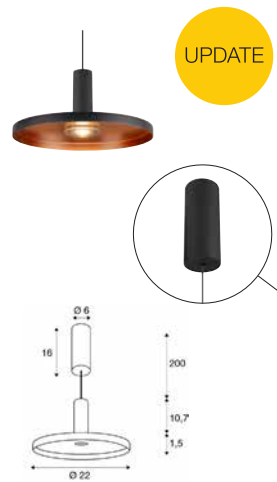

220-240 V ~50/60 Hz | 500 mA

Systemleistung: 9,5 W

Material: Aluminium/Stahl

220-240 V ~50/60 Hz | 500 mA

Systemleistung: 9,5 W

Material: Aluminium/Stahl

- inklusive Farbtemperaturschalter 2700K/3000K

- inklusive Farbtemperaturschalter 2700K/3000K



Down 700lm|2700 K | 800lm|3000 K



Down 700lm|2700 K | 700lm|3000 K

Variante	Art.Nr.	EUR
● schwarz	1010791	295,90

Variante	Art.Nr.	EUR
● schwarz	1010792	235,40

Entdecken Sie weitere Farben und Formen der LALU® auf KS-Licht.de



1010795 229

LALU® SET

PD, LED Base, Phase, Recessed



220-240 V ~50/60 Hz | 500 mA

Systemleistung: 9,5 W

Material: Aluminium/Stahl

- inklusive Farbtemperaturschalter
2700K/3000K



1010795 229



Down 550lm|2700 K | 600lm|3000 K

Variante	Art.Nr.	EUR
● schwarz	1010793	● 254,40



LALU® SET

PD, LED Base, Phase, Recessed



220-240 V ~50/60 Hz | 500 mA
 Systemleistung: 9,5 W
 Material: Aluminium/Stahl

- inklusive Farbtemperaturschalter
 2700K/3000K



Down 650 lm | 2700 K | 700 lm | 3000 K

Variante	Art.Nr.	EUR
● schwarz	1010794	● 260,20

LALU® SET

PD, LED Base, Phase, Recessed



220-240 V ~50/60 Hz | 500 mA
 Systemleistung: 9,5 W
 Material: Aluminium/Stahl

- inklusive Farbtemperaturschalter
 2700K/3000K



Down 700 lm | 2700 K | 800 lm | 3000 K

Variante	Art.Nr.	EUR
● schwarz	1010795	● 285,90

LALU® SET

PD, LED Base, Phase, Recessed

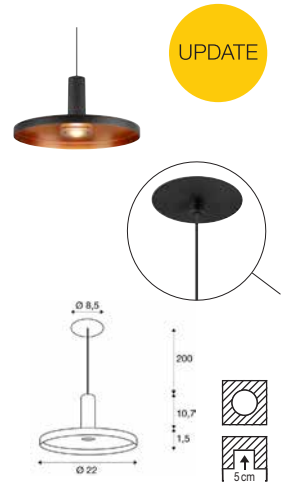

220-240 V ~50/60 Hz | 500 mA
 Systemleistung: 9,5 W
 Material: Aluminium/Stahl

- inklusive Farbtemperaturschalter
 2700K/3000K



Down 700 lm | 2700 K | 700 lm | 3000 K

Variante	Art.Nr.	EUR
● schwarz	1010796	● 225,40

Entdecken Sie weitere Farben und Formen der LALU® auf KS-Licht.de

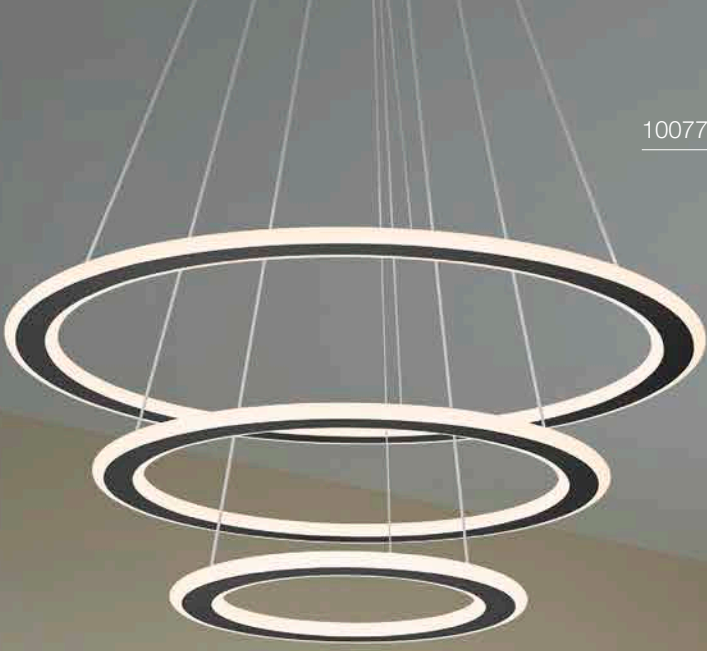



ONE FLAT PD, DALI, triple

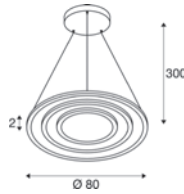

220-240 V ~50/60 Hz | 1700 mA
Systemleistung: 58 W
Material: Aluminium/Stahl

ONE FLAT PD, PHASE, single

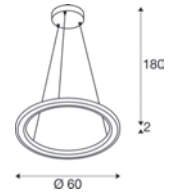

220-240 V ~50/60 Hz | 600 mA
Systemleistung: 23 W
Material: Aluminium/Stahl



3500lm|2700 K | 3700lm|3000 K

Variante	Art.Nr.	EUR
● schwarz	1007701	1.150,00
○ weiß	1007702	1.150,00
● messing	1007703	1.150,00



1300-1900 lm|2700 K | 1350-2050 lm|3000 K

Variante	Art.Nr.	EUR
● schwarz	1007855	485,00
○ weiß	1007856	485,00
● messing	1007857	485,00

1008004 233





ONE VERTICAL PD, PHASE

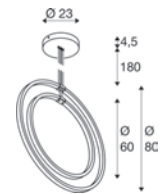

220–240 V ~50/60 Hz | 1050 mA

Systemleistung: 40 W

Material: Aluminium/Stahl



2400 lm | 2700 K | 2550 lm | 3000 K

Variante	Art.Nr.	EUR
● schwarz	1008002	485,00
○ weiß	1008003	485,00
● messing	1008004	485,00



1007665 235





ONE CUBE PD, DALI

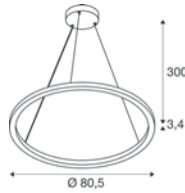

220-240 V ~50/60 Hz | 1400 mA
Systemleistung: 54 W
Material: Aluminium/Stahl

ONE CUBE PD, DALI, up/down

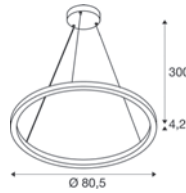

220-240 V ~50/60 Hz | 2100 mA
Systemleistung: 80 W
Material: Aluminium/Stahl

ONE Filzplatte, Akustik Filz, f. ONE 80/ ONE CUBE



Ø: 75.5 cm
H: 3,8 cm
Material: Filz

- Passt in alle One Leuchtenringe mit Ø 80 cm

Variante	Art.Nr.	EUR
● grau	1007746	109,00
● beige	1007891	109,00



4000 lm | 3000 K | 4300 lm | 4000 K

Variante	Art.Nr.	EUR
● schwarz 3000 K	1007661	629,00
● schwarz 4000 K	1007663	629,00
○ weiß 3000 K	1007662	629,00
○ weiß 4000 K	1007664	629,00



4000 lm | 3000 K | 4300 lm | 4000 K

Variante	Art.Nr.	EUR
● schwarz 3000 K	1007665	699,00
● schwarz 4000 K	1007671	699,00
○ weiß 3000 K	1007666	699,00
○ weiß 4000 K	1007672	699,00



1005177 237





ONE 60 PD, DALI



220-240 V ~50/60 Hz | 600 mA
Systemleistung: 24 W
Material: Aluminium/Stahl



1480 lm | 3000 K | 1550 lm | 4000 K

Variante	Art.Nr.	EUR
● schwarz	1002909	423,00
○ weiß	1002910	423,00

ONE 60 PD, DALI, up/down

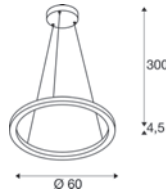

220-240 V ~50/60 Hz | 600 mA
Systemleistung: 25 W
Material: Aluminium/Stahl



Up 400 lm | 3000 K | 410 lm | 4000 K
Down 400 lm | 3000 K | 410 lm | 4000 K

Variante	Art.Nr.	EUR
● schwarz	1004761	535,00
○ weiß	1004762	535,00

ONE 60 PD, PHASE, up/down



220-240 V ~50/60 Hz | 600 mA
Systemleistung: 24 W
Material: Aluminium/Stahl



Up 410 lm | 2700 K | 415 lm | 3000 K
Down 410 lm | 2700 K | 415 lm | 3000 K

Variante	Art.Nr.	EUR
● schwarz	1004759	484,00
○ weiß	1004760	484,00
● messing	1005177	504,00

1004763 239





ONE 80 PD, DALI

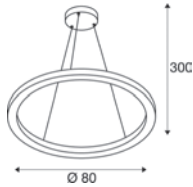

220-240 V ~50/60 Hz | 800 mA
Systemleistung: 32 W
Material: Aluminium/Stahl



1930 lm | 3000 K | 2140 lm | 4000 K

Variante	Art.Nr.	EUR
● schwarz	1002911	474,00
○ weiß	1002912	474,00

ONE 80 PD, DALI, up/down

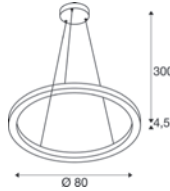

220-240 V ~50/60 Hz | 800 mA
Systemleistung: 34 W
Material: Aluminium/Stahl



Up 615 lm | 3000 K | 635 lm | 4000 K
Down 615 lm | 3000 K | 635 lm | 4000 K

Variante	Art.Nr.	EUR
● schwarz	1004763	636,00
○ weiß	1004764	636,00

ONE Filzplatte, Akustik Filz, f. ONE 80/ ONE CUBE



Ø: 75.5 cm
H: 3,8 cm
Material: Filz

- Passt in alle One Leuchtenringe mit Ø 80 cm

Variante	Art.Nr.	EUR
● grau	1007746	109,00
● beige	1007891	109,00

ONE DOUBLE PD, DALI, up/down

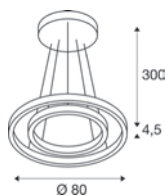

220-240 V ~50/60 Hz | 1400 mA
Systemleistung: 55 W
Material: Aluminium/Stahl



Up	1050 lm	3000 K	1060 lm	4000 K
Down	1050 lm		1060 lm	

Variante	Art.Nr.	EUR
● schwarz	1004767	1.110,00
○ weiß	1004768	1.110,00

ONE DOUBLE PD, PHASE, up/down

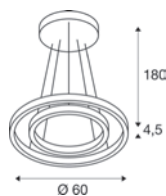

220-240 V ~50/60 Hz | 900 mA
Systemleistung: 35 W
Material: Aluminium/Stahl



Up	615 lm	2700 K	635 lm	3000 K
Down	615 lm		635 lm	

Variante	Art.Nr.	EUR
● schwarz	1004765	827,00
○ weiß	1004766	827,00
● messing	1005178	848,00





ONE TRIPLE PD, DALI

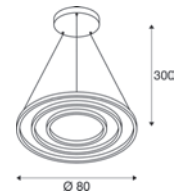

220-240 V ~50/60 Hz | 1700 mA
Systemleistung: 64 W
Material: Aluminium/Stahl



4040 lm | 3000 K | 4200 lm | 4000 K

Variante	Art.Nr.	EUR
● schwarz	1002913	1.110,00
○ weiß	1002914	1.110,00

1005178 240

1006188 243





ONE LINEAR 100

PD, PHASE, up/down

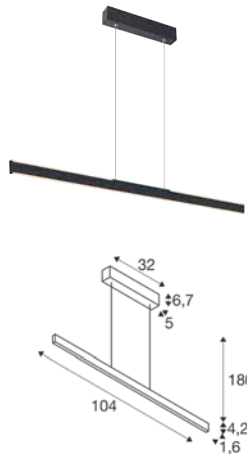

220-240 V ~50/60 Hz | 600 mA
 Systemleistung: 24 W
 Material: Aluminium/Stahl



Up 550 lm | 2700 K | 580 lm | 3000 K

Variante	Art.Nr.	EUR
● schwarz	1006185	312,00

ONE LINEAR 140

PD, PHASE, up/down

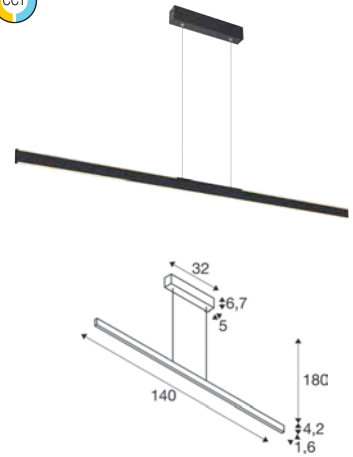

220-240 V ~50/60 Hz | 900 mA
 Systemleistung: 35 W
 Material: Aluminium/Stahl



Up 830 lm | 2700 K | 860 lm | 3000 K
 Down 980 lm | 2700 K | 1015 lm | 3000 K

Variante	Art.Nr.	EUR
● schwarz	1006188	368,00
○ weiß	1006189	368,00
● messing	1006190	388,00



1007588 245



1007599 245



1007597 245



PANTILO ROPE 19

PD, E27

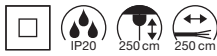
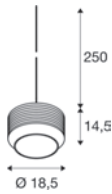

220-240 V ~50/60 Hz
Material: Glas

- offenes Kabelende
- Passendes Zubehör finden Sie auf Seite 271



Socket: 1xE27 max. Ø: 10 cm | L: 11 cm

Variante	Art.Nr.	EUR
● gold	1007597	199,00
○ silber	1007596	199,00



E27 | 8 W | 320°
800 lm | 2700 K | EEK = F
8 kWh/1000h



Art.Nr.: 1005303 9,60 EUR



E27 | 7 W | 300°
640 lm | 2200-4000 K | EEK = G
7 kWh/1000h



Art.Nr.: 1010486 28,00 EUR

PANTILO ROPE 20

PD, E27

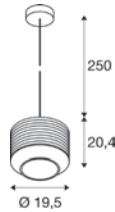

220-240 V ~50/60 Hz
Material: Glas



Socket: 1xE27 max. Ø: 10 cm | L: 18 cm

Variante	Art.Nr.	EUR
● gold	1007589	239,00
○ silber	1007588	239,00



E27 | 8 W | 320°
800 lm | 2700 K | EEK = F
8 kWh/1000h



Art.Nr.: 1005303 9,60 EUR



E27 | 7 W | 300°
640 lm | 2200-4000 K | EEK = G
7 kWh/1000h



Art.Nr.: 1010486 28,00 EUR

PANTILO ROPE 27

PD, E27



220-240 V ~50/60 Hz
Material: Glas



Socket: 1xE27 max. Ø: 15 cm | L: 11 cm

Variante	Art.Nr.	EUR
● gold	1007599	259,00
○ silber	1007598	259,00



E27 | 8 W | 320°
800 lm | 2700 K | EEK = F
8 kWh/1000h



Art.Nr.: 1005303 9,60 EUR



E27 | 7 W | 300°
640 lm | 2200-4000 K | EEK = G
7 kWh/1000h



Art.Nr.: 1010486 28,00 EUR

1006402 247

1006400 247

1006398 247

1006403 247





PANTILO OVAL PD, E27



220-240 V ~50/60 Hz
Material: Aluminium

- offenes Kabelende
- Passendes Zubehör finden Sie auf Seite 271

PANTILO PD, E27

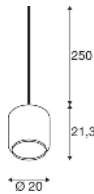

220-240 V ~50/60 Hz
Material: Glas

- offenes Kabelende
- Passendes Zubehör finden Sie auf Seite 271

PANTILO 28 PD, E27

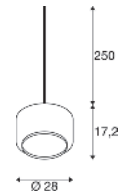

220-240 V ~50/60 Hz
Material: Glas

- offenes Kabelende
- Passendes Zubehör finden Sie auf Seite 271



Socket: 1xE27

Variante	Art.Nr.	EUR
○ weiß	1006402	155,00
● gold	1006403	175,00
● chrom	1006398	175,00
● kupfer	1006400	175,00



E27 | 8 W | 320°
800 lm | 2700 K | EEK = F
8 kWh/1000h



Art.Nr.: 1005303 9,60 EUR



Socket: 1xE27

Variante	Art.Nr.	EUR
○ weiß	1006396	155,00
● gold	1006395	175,00
● chrom	1003004	175,00
● kupfer	1003005	175,00



E27 | 8 W | 320°
800 lm | 2700 K | EEK = F
8 kWh/1000h



Art.Nr.: 1005303 9,60 EUR



Socket: 1xE27

Variante	Art.Nr.	EUR
○ weiß	1006399	191,00
● gold	1006397	211,00
● chrom	1003006	211,00
● kupfer	1003007	211,00



E27 | 8 W | 320°
800 lm | 2700 K | EEK = F
8 kWh/1000h



Art.Nr.: 1005303 9,60 EUR



E27 | 7 W | 300°
640 lm | 2200-4000 K | EEK = G
7 kWh/1000h



Art.Nr.: 1010486 28,00 EUR



E27 | 7 W | 300°
640 lm | 2200-4000 K | EEK = G
7 kWh/1000h



Art.Nr.: 1010486 28,00 EUR



E27 | 7 W | 300°
640 lm | 2200-4000 K | EEK = G
7 kWh/1000h



Art.Nr.: 1010486 28,00 EUR

PANTILO CONVEX 29

PD, E27

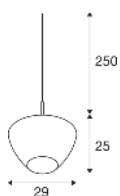

220-240 V ~50/60 Hz
Material: Glas/Stahl

- offenes Kabelende
- Passendes Zubehör finden Sie auf Seite 271



Socket: E27 max. Ø: 10 cm L: 20 cm

Variante	Art.Nr.	EUR
○ weiß	1007881	227,00
● gold	1007880	247,00
● chrom	1003443	247,00
● kupfer	1007879	247,00



E27 | 8 W | 320°
700 lm | 2500 K | EEK = F
8 kWh/1000h



Art.Nr.: 1005265 26,50 EUR



E27 | 7 W | 300°
640 lm | 2200-4000 K | EEK = G
7 kWh/1000h



Art.Nr.: 1010486 28,00 EUR

1007877 249





PANTILO CONVEX 40 PD, E27

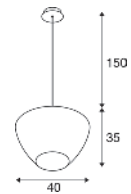

220-240 V ~50/60 Hz
Material: Glas/Stahl



Socket: E27

max. Ø: 15 cm | L: 30 cm

Variante	Art.Nr.	EUR
○ weiß	1007878	343,00
● gold	1007877	363,00
● chrom	1003444	353,00
● kupfer	1007876	363,00



E27 | 8 W | 320°
700 lm | 2500 K | EEK = F
8 kWh/1000h



Art.Nr.: 1005265 26,50 EUR



E27 | 7 W | 300°
640 lm | 2200-4000 K | EEK = G
7 kWh/1000h



Art.Nr.: 1010484 32,00 EUR

1008178+1008192 251





LIGHT EYE® 90 PD, QPAR51

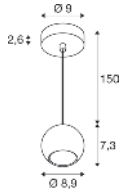

220-240 V ~50/60 Hz
Material: Stahl

LIGHT EYE® 150 PD, QPAR111

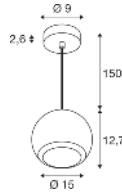

220-240 V ~50/60 Hz
Material: Stahl

LIGHT EYE® 90 Deco Ring Ø 5,7 cm



Ø: 5.9 cm
H: 1,4 cm
Material: Stahl

Variante	Art.Nr.	EUR
● schwarz	1008186	9,00
○ weiß	1008187	9,00
● gold	1008188	14,00
● chrom	151049	14,00



Socket: 1xGU10 max. Ø: 5,1 cm | L: 5,35 cm

Variante	Art.Nr.	EUR
● schwarz	1008172	84,00
○ weiß	1008173	84,00



GU10 | 6 W | 38°
450 lm | 2700 K | EEK = F
6 kWh/1000h



Art.Nr.: 1005077 7,50 EUR



Socket: 1xGU10 max. Ø: 11,1 cm | L: 7 cm

Variante	Art.Nr.	EUR
● schwarz	1008178	132,00
○ weiß	1008179	132,00



GU10 | 12 W | 55°
670 lm | 2700 K | EEK = G
12 kWh/1000h



Art.Nr.: 1005297 85,00 EUR

LIGHT EYE® 150 Deco Ring Ø 13,6 cm



Ø: 13.6 cm
H: 2,3 cm
Material: Stahl

Variante	Art.Nr.	EUR
● schwarz	1008189	35,00
○ weiß	1008190	35,00
● gold	1008192	45,00
● chrom	1008191	45,00



GU10 | 5 W | 36°
420 lm | 2200-6500 K | EEK = F
5 kWh/1000h



Art.Nr.: 1010470 39,00 EUR



GU10 | 10 W | 24°
750 lm | 2200-6500 K | EEK = G
10 kWh/1000h



Art.Nr.: 1010467 59,00 EUR

1006438

253





ASTO TUBE PD, GU10



220-240 V ~50/60 Hz
Material: Aluminium

- Dekoringe als Zubehör erhältlich



Socket: 1-4xGU10

Variante	Art.Nr.	EUR
● schwarz	1006431	60,00
○ weiß	1006432	60,00



GU10 | 6 W | 38°
450 lm | 2700 K | EEK = F
6 kWh/1000h



Art.Nr.: 1005077 7,50 EUR



GU10 | 5 W | 36°
420 lm | 2200-6500 K | EEK = F
5 kWh/1000h



Art.Nr.: 1010470 39,00 EUR

ASTO TUBE PD, single, GU10

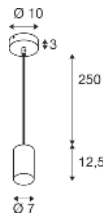

Variante	Art.Nr.	EUR
● schwarz	1006431	60,00
○ weiß	1006432	60,00

ASTO TUBE PD, double, GU10

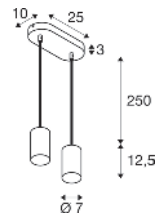
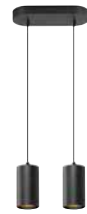

Variante	Art.Nr.	EUR
● schwarz	1006433	110,00
○ weiß	1006434	110,00

ASTO TUBE Dekoreflektor



Ø: 6,8 cm
H: 3,95 cm
Material: Polycarbonate (PC)

ASTO TUBE PD, triple, GU10

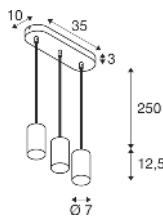

Variante	Art.Nr.	EUR
● schwarz	1006435	160,00
○ weiß	1006436	160,00

ASTO TUBE PD, quadruple, GU10

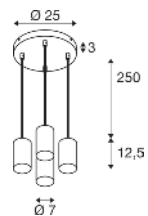
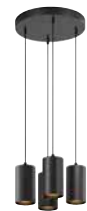

Variante	Art.Nr.	EUR
● schwarz	1006437	195,00
○ weiß	1006438	195,00

Variante	Art.Nr.	EUR
● schwarz/chrom	1007190	4,00
● gold	1006450	4,00
● chrom	1006449	4,00
● kupfer	1006451	4,00

1010516 255





GLENOS® PRO

PD, 1,2m, DALI, UGR16

GLENOS® PRO

PD, 1,5m, DALI, UGR16

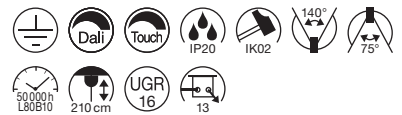

220-240 V ~0/50/60 Hz | 1600 mA
 Systemleistung: 60 W
 Material: Aluminium/Kunststoff PC

220-240 V ~0/50/60 Hz | 1850 mA
 Systemleistung: 70 W
 Material: Aluminium/Kunststoff PC



Up	3700 lm	3000 K
Down	3200 lm	
Up	4000 lm	4000 K
Down	4400 lm	

Up	4350 lm	3000 K
Down	3600 lm	
Up	4600 lm	4000 K
Down	5550 lm	

Variante	Art.Nr.	EUR
● schwarz 6900 lm 3000 K	1010510	459,00
● schwarz 7400 lm 4000 K	1010512	459,00
● weiß/schwarz 7500 lm 3000 K	1010509	459,00
● weiß/schwarz 7800 lm 4000 K	1010511	459,00

Variante	Art.Nr.	EUR
● schwarz 7950 lm 3000 K	1010514	499,00
● schwarz 8450 lm 4000 K	1010516	499,00
● weiß/schwarz 8500 lm 3000 K	1010513	499,00
● weiß/schwarz 9400 lm 4000 K	1010515	499,00



1006345 257



WORKLIGHT PD, DALI

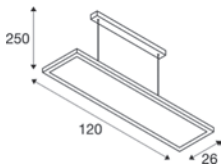
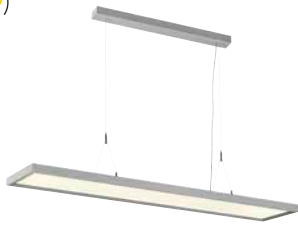

220-240 V ~50/60 Hz | 1550 mA
Systemleistung: 57 W
Material: Aluminium

- Schutzkontaktstecker



Down 3000 lm | 4000 K
Up 2000 lm

Variante	Art.Nr.	EUR
● schwarz	1005395	469,00
○ weiß	1005396	469,00
○ silber	1006345	469,00

WORKLIGHT PRO 120 PD, DALI

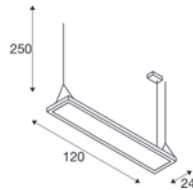

220-240 V ~50/60 Hz | 1200 mA
Systemleistung: 50 W
Material: Aluminium/Stahl

- BEG förderfähig



Down 3300 lm | 4000 K
Up 2800 lm

Variante	Art.Nr.	EUR
● schwarz	1007468	499,00
○ weiß	1007469	499,00
● grau	1007470	499,00

WORKLIGHT PRO 150 PD, DALI

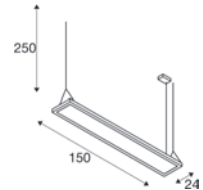

220-240 V ~50/60 Hz | 1400 mA
Systemleistung: 59 W
Material: Aluminium/Stahl

- BEG förderfähig



Down 3900 lm | 4000 K
Up 3300 lm

Variante	Art.Nr.	EUR
● schwarz	1007471	599,00
○ weiß	1007472	599,00
● grau	1007473	599,00

1010429 259





PANEL 60
PD, round, PHASE

PANEL 60
PD, round, DALI

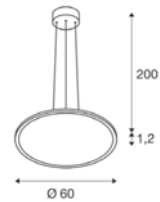
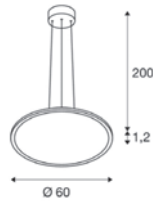
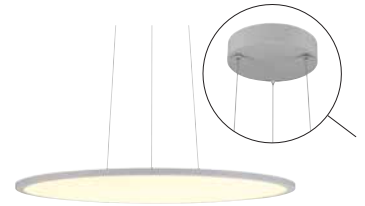
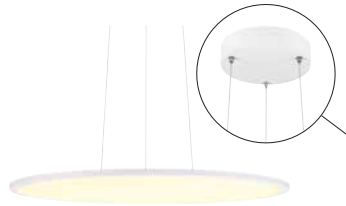

220-240 V ~50/60 Hz | 750 mA
Systemleistung: 29 W
Material: Aluminium/Stahl

220-240 V ~50/60 Hz | 750 mA
Systemleistung: 29 W
Material: Aluminium/Stahl



3050 lm | 3000 K | 3300 lm | 4000 K

3050 lm | 3000 K | 3300 lm | 4000 K

Variante	Art.Nr.	EUR
○ weiß	1010426	315,00
● grau	1010427	315,00

Variante	Art.Nr.	EUR
○ weiß	1010428	325,00
● grau	1010429	325,00

1001403 261





GLENOS®
PD, 1m, 1-10V

GLENOS®
PD, 2m, 1-10V

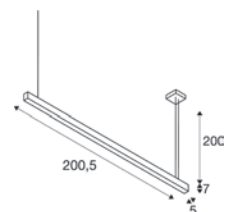
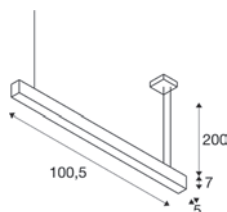
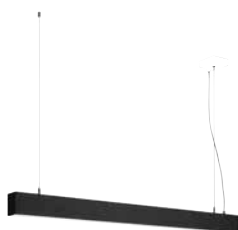

220-240 V ~50/60 Hz | 1000 mA
Systemleistung: 43 W
Material: Aluminium/Kunststoff

220-240 V ~50/60 Hz | 1000 mA
Systemleistung: 85 W
Material: Aluminium/Kunststoff



2850 lm | 3000 K | 3300 lm | 4000 K



5700 lm | 3000 K | 6600 lm | 4000 K

Variante	Art.Nr.	EUR
● schwarz 3000 K	1001400	393,00
● schwarz 4000 K	1001403	393,00

Variante	Art.Nr.	EUR
● schwarz 3000 K	1001406	540,00
● schwarz 4000 K	1001409	540,00



1001309 263

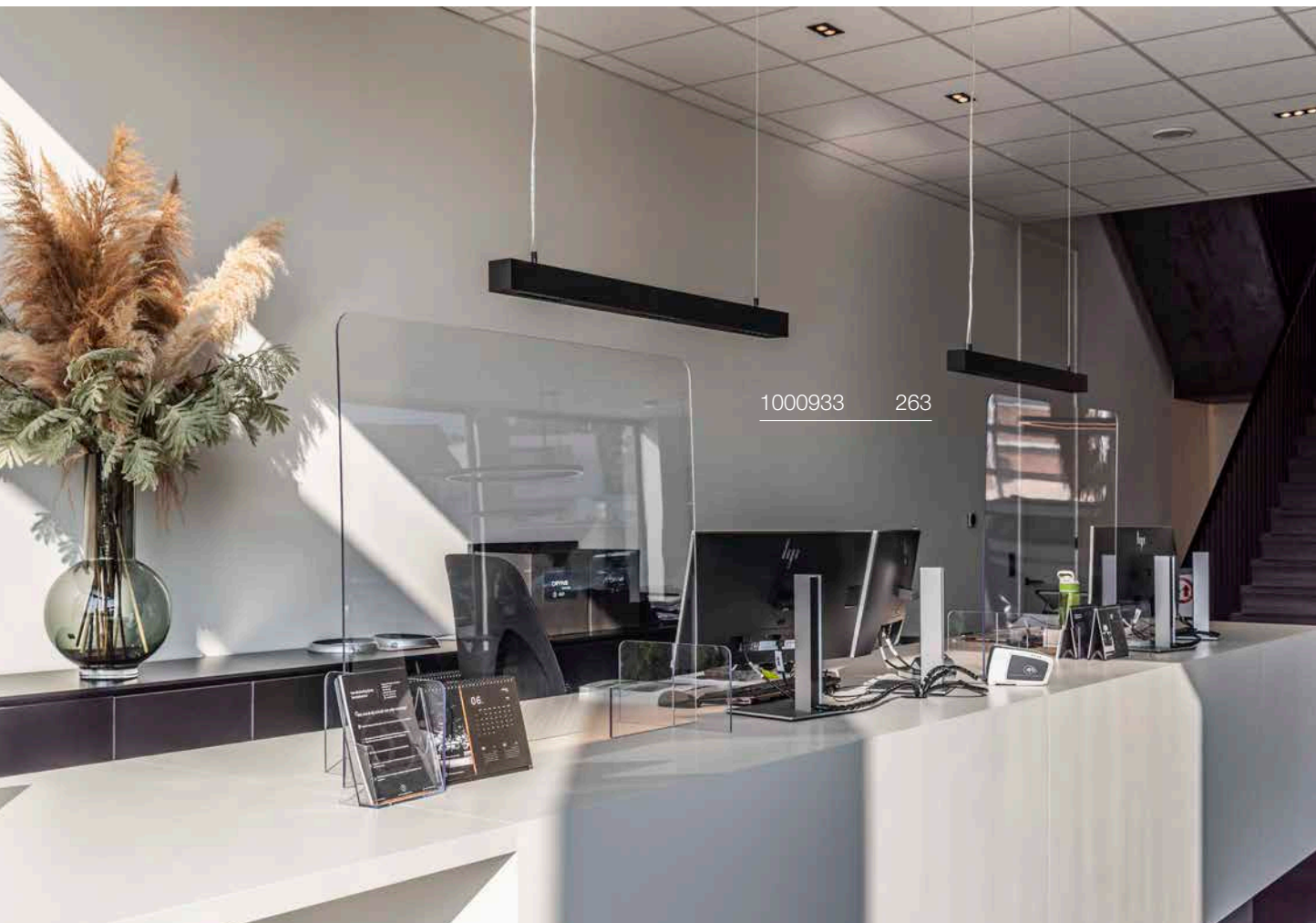

1000933 263



Q-LINE®
PD, 1m, BAP, PHASE

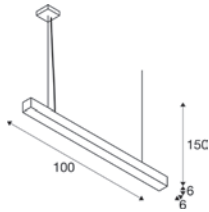
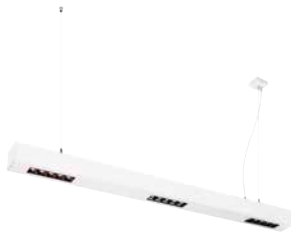

220-240 V ~50/60 Hz | 900 mA
Systemleistung: 46 W
Material: Aluminium/Kunststoff



2100 lm | 3000 K | 2300 lm | 4000 K

Variante	Art.Nr.	EUR
● schwarz 3000 K	1000927	484,00
● schwarz 4000 K	1000933	484,00
○ weiß 3000 K	1000926	484,00
○ weiß 4000 K	1000932	484,00

Q-LINE®
PD, 2m, BAP, PHASE

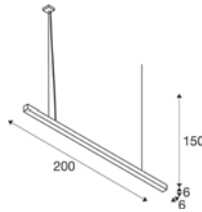

220-240 V ~50/60 Hz | 900 mA
Systemleistung: 93 W
Material: Aluminium/Kunststoff



4200 lm | 3000 K | 4600 lm | 4000 K

Variante	Art.Nr.	EUR
● schwarz 3000 K	1000930	726,00
● schwarz 4000 K	1000936	726,00
○ weiß 3000 K	1000929	726,00
○ weiß 4000 K	1000935	726,00

Q-LINE®
PD

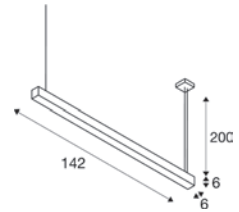
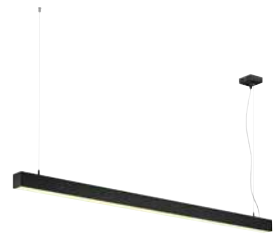

Systemleistung: 46 W
Material: Aluminium/Kunststoff PC



Down 4100 lm | 3000 K

Variante	Art.Nr.	EUR
● schwarz	1001309	580,00
○ weiß	1001310	580,00



1009015 265



GRIP! FLAT PD, PHASE



UPDATE

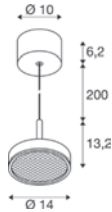

220-240 V ~50/60 Hz | 500 mA
Systemleistung: 16 W

- Inklusive Farbtemperaturschalter
2700K/3000K
- Inklusive Honeycomb



Down 400 lm | 2700 K | 430 lm | 3000 K

Variante	Art.Nr.	EUR
● schwarz/gold	1009014	289,00
● weiß/schwarz	1009015	289,00



Artikel	Art.Nr.	EUR
GRIP! FLAT Dekoring		
● schwarz	1009102	32,00
○ weiß	1009103	32,00
● gold	1009104	32,00
Felt shade A		
● schwarz	1010403	139,00
● grau	1010404	139,00
● ocker	1010405	139,00
Felt shade B		
● schwarz	1010406	99,00
● grau	1010407	99,00
● ocker	1010408	99,00

GRIP! FLAT Felt shade Ø 50 cm x 6,2 cm



UPDATE

Ø: 50 cm
H: 6,2 cm

Variante	Art.Nr.	EUR
● schwarz	1010403	139,00
● grau	1010404	139,00
● ocker	1010405	139,00

GRIP! FLAT Felt shade Ø 50 cm x 0,6 cm

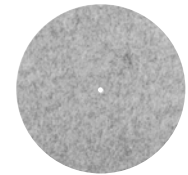

UPDATE

Ø: 50 cm
H: 0,6 cm

Variante	Art.Nr.	EUR
● schwarz	1010406	99,00
● grau	1010407	99,00
● ocker	1010408	99,00

OCULUS

PD, single, PHASE

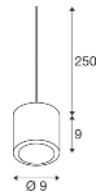

220-240 V ~50/60 Hz | 250 mA

Systemleistung: 11 W

Material: Aluminium

- Zusätzliche gefrostete Linse inklusive
- Passendes Zubehör finden Sie auf Seite 271
- offenes Kabelende



36 lm|2000 K - 780 lm|3000 K

Variante	Art.Nr.	EUR
● schwarz	1004672	209,00
○ weiß	1004673	209,00

1004672 266

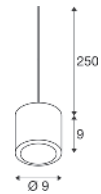

**OCULUS**
PD, DTW, PVD

1008617 267



220-240 V ~50/60 Hz | 250 mA

Systemleistung: 11 W

Material: Aluminium



Down 36 lm | 2000 K - 780 lm | 3000 K

Variante	Art.Nr.	EUR
● messing	1008616	295,00
● dunkel bronze	1008615	295,00
● dunkel kupfer	1008617	295,00

1010419+1008159 269+1004





FITU PD, E27

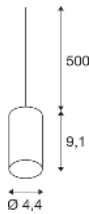

220-240 V ~50/60 Hz
Material: Aluminium

- Textilkabel
- Passendes Zubehör finden Sie auf Seite 271
- offenes Kabelende



Socket: 1xE27

Variante	Art.Nr.	EUR
● schwarz	132690	60,00
○ weiß	132691	60,00



E27 | 8 W | 320°
800 lm | 2700 K | EEK = F
8 kW/1000h



Art.Nr.: 1005303 9,60 EUR

FITU PD, E27, stone

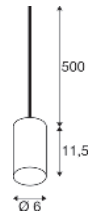

220-240 V ~50/60 Hz
Material: Stein

- offenes Kabelende



Socket: 1xE27

Variante	Art.Nr.	EUR
● schwarz	1010417	84,00
● grau	1010419	84,00
● beige	1010418	84,00



E27 | 6 W | 330°
260 lm | 1900 K |
6 kW/1000h



Art.Nr.: 1008163 84,00 EUR

FITU PD, E27, ribbed

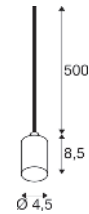

220-240 V ~50/60 Hz
Material: Aluminium

- offenes Kabelende



Socket: 1xE27

Variante	Art.Nr.	EUR
● schwarz	1010420	59,00
● gold	1010421	59,00



E27 | 4 W | 325°
250 lm | 1800 K | EEK = G
4 kW/1000h



Art.Nr.: 1008645 5,90 EUR

132690

269

DE INSTALLATIE
ALLES KEURIG
GERUIMD.
"stof op de koozinen
AFGEDAAN"



SAMAN

SAMEN IN TECHNIEK

"ik ben zeer tevreden
over de NETTE, PROFESSIONELE
& Klantvriendelijke
WERKWIJZE"

"VOOR MIJ IS HET
BELANGRIJK
— dat ik een —
KLITIK
MET HET BEURIJF HEB.
EN DAT HAD IK METEEN MET
SAMAN Groep

- » VAN ZONNE PANEEL TOT LAADPAAL
- » VAN DAK GOOT TOT CV-KETEL
- » VAN STOPCONTACT TOT DATANETWERK
- » VAN ROOSTERVLOER TOT HEKWERK



**FITU | 1er Deckenrosette**

16A max.
H: 3,9 cm
Material: Stahl
inkl. Zugentlastung



Variante	Art.Nr.	EUR
● schwarz	132600	26,00
○ weiß	132601	26,00
● gold	1002163	28,50
● chrom	132605	28,50

FITU | 3er Deckenrosette

16A max.
H: 5,4 cm
Material: Stahl
inkl. Zugentlastung



Variante	Art.Nr.	EUR
● schwarz	132610	63,00
○ weiß	132611	63,00

FITU | Deckenrosette Aufbau

16A max.
H: 2,6 cm
Ø: 9 cm
Material: Stahl



Variante	Art.Nr.	EUR
● schwarz	1004744	34,00
○ weiß	1004745	34,00
● gold	1006377	37,25

FITU | Deckenrosette Einbau

16A max.
H: 3,3 cm
Material: Stahl/Polyamide
66 (PA)



Variante	Art.Nr.	EUR
● schwarz	1004674	22,50
○ weiß	1004675	22,50
● gold	1006378	27,00

FITU | Deckenhaken

L: 4,6 cm
Material: Aluminium



Variante	Art.Nr.	EUR
● schwarz	132670	19,20
○ weiß	132671	19,20

1-Phasen Leuchtenadapter

6A max.
H: 3,2 cm
L: 8,5 cm
B: 3,5 cm
Material: Polycarbonate (PC)



Variante	Art.Nr.	EUR
● schwarz	143120	15,00
○ weiß	143121	15,00
● grau	143124	15,00

3-Phasen Leuchtenadapter

16A max.
H: 4,5 cm
L: 9,6 cm
B: 3,5 cm
Material: Kunststoff



Variante	Art.Nr.	EUR
● schwarz	145990	19,70
○ weiß	1001542	19,70
● grau	145994	19,70

FITU | Kabelklemme

L: 3,1 cm
Material: Aluminium



Variante	Art.Nr.	EUR
● schwarz	132680	12,50
○ weiß	132681	12,50

FENDA
PD, E27

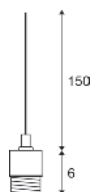

220-240 V ~50/60 Hz
Material: Stahl/Kunststoff

- offenes Kabelende
- Passendes Zubehör finden Sie auf Seite 271



Socket: 1xE27

Variante	Art.Nr.	EUR
● schwarz	132660	29,25
○ weiß	132661	29,25
● chrom	132662	33,00



E27 | 8 W | 320°
800lm | 2700 K | EEK = F
8 kWh/1000h



Art.Nr.: 1005303 9,60 EUR



E27 | 7 W | 300°
640lm | 2200-4000 K | EEK = G
7 kWh/1000h



Art.Nr.: 1010486 28,00 EUR

132661+1000579 272+273



1000773 273



FENDA

Ø 45 cm, rund



Ø: 45,5 cm
H: 28 cm
Material: Textile/Stahl

Variante	Art.Nr.	EUR
● schwarz/kupfer	156122	88,00
○ weiß	156111	83,00
● grau	1004775	83,00
● beige	156113	83,00



Artikel	Art.Nr.	EUR
Acrylglasabdeckung für FENDA Ø 45,5 cm		
○ weiß	156100	44,50

FENDA

Glasschirm 12,5 cm, rund



Ø: 12,5 cm
H: 20 cm
Material: Glas

Variante	Art.Nr.	EUR
● braun	1000773	65,00

FENDA

Ø 70 cm, rund



Ø: 70 cm
H: 36 cm
Material: Textile/Stahl

- Nicht für Fenda Bow geeignet

Variante	Art.Nr.	EUR
● schwarz/kupfer	1000580	129,00
○ weiß	1000579	112,00



Artikel	Art.Nr.	EUR
Acrylglasabdeckung für FENDA Ø 70 cm		
○ weiß	1000957	94,00

FENDA

15 cm, rund



Ø: 15 cm
H: 40 cm
Material: Textile/Stahl

Variante	Art.Nr.	EUR
● grau	1004773	44,75

FENDA

Ø 30 cm, rund



Ø: 30 cm
H: 20 cm
Material: Textile/Stahl

Variante	Art.Nr.	EUR
● schwarz/kupfer	155592	70,00
○ weiß	155582	53,00
● grau	1004774	53,00
● beige	155583	53,00



Artikel	Art.Nr.	EUR
Acrylglasabdeckung für FENDA Ø 30 cm		
○ weiß	155570	29,25

MIX & MATCH FENDA

FENDA TL

Schwarz | 155780



FENDA FL

Schwarz | 155790



FENDA TL

Schwarz | 155540



FENDA FL

Schwarz | 155490

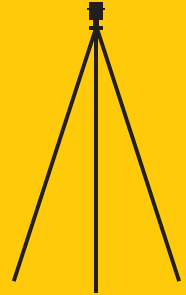

FENDA Ø15

Schwarz | 156152
Weiß | 156141
Beige | 156143
Grau | 1004773

FENDA Ø30

Schwarz | 155592
Weiß | 155582
Beige | 155583
Grau | 1004774

FENDA Ø45

Schwarz | 156122
Weiß | 156111
Beige | 156113
Grau | 1004775



FITU PD

Schwarz | 132690
Weiß | 132691

Stone

Schwarz | 1010417
Beige | 1010418
Grau | 1010419

Ribbed

Schwarz | 1010420
Gold | 1010421

FENDA PD

Schwarz | 132660
Weiß | 132661
Chrom | 132662

FENDA CL

Schwarz | 155550
Weiß | 155551

FITU CRANE BASE

Schwarz | 1004682



FENDA Ø70

Schwarz | 1000580
Weiß | 1000579



FENDA Ø12,5

Glass Shade

Braun | 1000773



Kombinieren Sie SLV Mix & Match Produkte ganz nach Ihrem Geschmack. Perfekt aufeinander abgestimmt, können Sie nicht nur innerhalb der FENDA Familie, sondern auch zwischen den Produktfamilien FENDA und FITU kombinieren. SLV Mix & Match Produkte erkennen Sie an dem folgenden Symbol:



MIX
match

HELIA 30

PD, PHASE

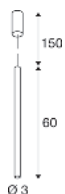
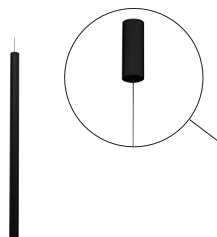

220-240 V ~50/60 Hz | 500 mA
 Systemleistung: 9,2 W
 Material: Aluminium



590lm|3000 K

Variante	Art.Nr.	EUR
● schwarz	152360	219,00

HELIA 30

PD

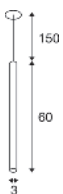
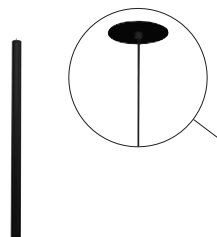

500 mA
 Systemleistung: 7,5 W
 Material: Aluminium

- Das Produkt ist mit einer Deckenrosette ausgestattet
- Materialstärke Einbaulfläche 12 mm max.



500lm|3000 K

Variante	Art.Nr.	EUR
● schwarz	158400	179,00



Artikel	Art.Nr.	EUR
LED Treiber 21W 500mA inkl. Zugentlastung		
○ weiß	1007226	30,00
LED Treiber 20W 350mA/500mA		
Phasenabschnitt dimmbar inkl. Zugentlastung		
○ weiß	1007227	40,00
LED Treiber 25W 150-700mA einstellbar		
DALI dimmbar inkl. Zugentlastung		
○ weiß	1007229	70,00



152360 + 152370 276 + 277



HELIA 40 PD, PHASE

HELIA 40 PD

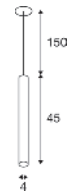
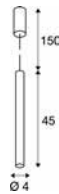
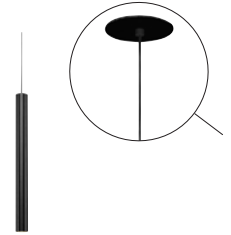
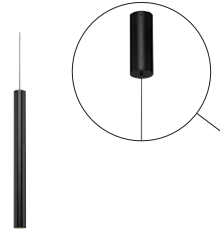

220-240 V ~50/60 Hz | 500 mA
Systemleistung: 10 W
Material: Aluminium



500 mA
Systemleistung: 9 W
Material: Aluminium

- Das Produkt ist mit einer Deckenrosette ausgestattet
- Material Einbaufäche: 12 mm max.



750lm|3000 K

Variante	Art.Nr.	EUR
● schwarz	152370	249,00



750lm|3000 K

Variante	Art.Nr.	EUR
● schwarz	158410	199,00



Artikel	Art.Nr.	EUR
LED Treiber 21W 500mA inkl. Zugentlastung		
○ weiß	1007226	30,00
LED Treiber 20W 350mA/500mA Phasenabschnitt dimmbar inkl. Zugentlastung		
○ weiß	1007227	40,00
LED Treiber 25W 150-700mA einstellbar DALI dimmbar inkl. Zugentlastung		
○ weiß	1007229	70,00

1008134 279





ENOLA® B PD, QPAR51

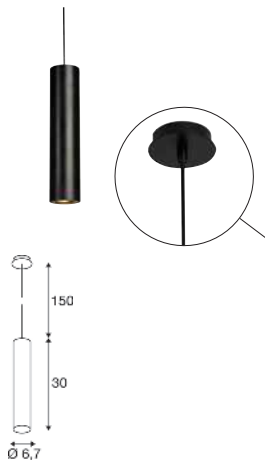

220-240 V ~50/60 Hz
Material: Aluminium/Stahl



Socket: 1xGU10

Variante	Art.Nr.	EUR
● schwarz	151850	110,00
○ weiß	151851	110,00
● gold	151853	115,00



GU10 | 6 W | 38°
450 lm | 2700 K | EEK = F
6 kWh/1000h



Art.Nr.: 1005077 7,50 EUR



GU10 | 5 W | 36°
420 lm | 2200-6500 K | EEK = F
5 kWh/1000h



Art.Nr.: 1010470 39,00 EUR

ENOLA® PD, E27

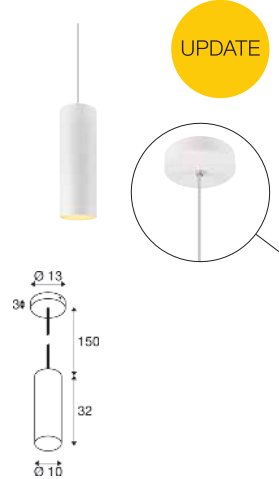

220-240 V ~50/60 Hz
Material: Aluminium/Stahl



Socket: 1xE27 max. Ø: 9 cm | L: 18 cm

Variante	Art.Nr.	EUR
● schwarz	1008135	81,00
○ weiß	1008133	81,00
● gold	1008134	94,00



E27 | 4 W | 280°
830 lm | 2700 K | EEK = A
4 kWh/1000h



Art.Nr.: 1008641 7,50 EUR

ANELA PD, PHASE

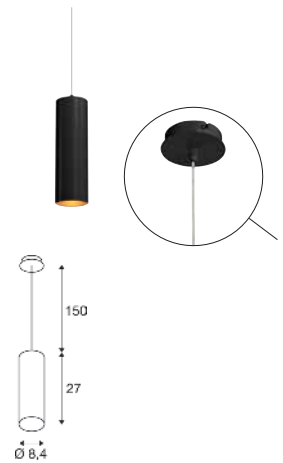

220-240 V ~50/60 Hz | 500 mA
Systemleistung: 10 W
Material: Aluminium

- Reflektor exkl.
- Lichtstrom mit Reflektor 1000809 = 500lm/
Lichtstrom mit Reflektor 1000810 = 620lm/
Lichtstrom mit Reflektor 1000811 = 200lm/
Lichtstrom mit Reflektor 1000812 = 600lm



240 lm | 3000 K | 820 lm

Variante	Art.Nr.	EUR
● schwarz	1000813	198,00



Artikel	Art.Nr.	EUR
Reflektor 28°		
● gold	1000809	20,00
● grau	1000810	20,00
● schwarz	1000811	20,00
○ weiß	1000812	20,00

1008131 281





1008130 281



PARA CONE 20 PD, E27

PARA CONE 30 PD, E27

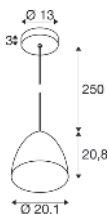

220-240 V ~50/60 Hz
Material: Aluminium/Stahl



Socket: 1xE27

Variante	Art.Nr.	EUR
● gold/schwarz	1008129	117,00
○ kupfer/weiß	1008130	164,00



E27 | 6 W | 330°
570 lm | 2200 K | EEK = F
6 kWh/1000h



Art.Nr.: 1008153 54,00 EUR



E27 | 7 W | 300°
640 lm | 2200-4000 K | EEK = G
7 kWh/1000h



Art.Nr.: 1010486 28,00 EUR

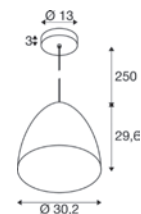

220-240 V ~50/60 Hz
Material: Aluminium/Stahl



Socket: 1xE27

Variante	Art.Nr.	EUR
● schwarz/gold	1008131	198,00
○ kupfer/weiß	1008132	222,00



E27 | 6 W | 330°
570 lm | 2200 K | EEK = F
6 kWh/1000h



Art.Nr.: 1008153 54,00 EUR



E27 | 7 W | 300°
640 lm | 2200-4000 K | EEK = G
7 kWh/1000h



Art.Nr.: 1010484 32,00 EUR

1002949 + 1002950 + 1002951

283





PHELIA 10 PD, E27

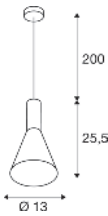

220-240 V ~50/60 Hz
Material: Aluminium

- Textilkabel



Socket: 1xE27

Variante	Art.Nr.	EUR
● schwarz/gold	1002951	131,00



E27 | 8 W | 180°
720 lm | 2700 K | EEK = F
8 kWh/1000h



Art.Nr.: 1005305 19,00 EUR



E27 | 7 W | 300°
640 lm | 2200-4000 K | EEK = G
7 kWh/1000h



Art.Nr.: 1010486 28,00 EUR

PHELIA 20 PD, E27

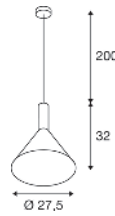

220-240 V ~50/60 Hz
Material: Aluminium

- Textilkabel



Socket: 1xE27

Variante	Art.Nr.	EUR
● schwarz/gold	1002949	161,00



E27 | 8 W | 180°
720 lm | 2700 K | EEK = F
8 kWh/1000h



Art.Nr.: 1005305 19,00 EUR



E27 | 7 W | 300°
640 lm | 2200-4000 K | EEK = G
7 kWh/1000h



Art.Nr.: 1010486 28,00 EUR

PHELIA 30 PD, E27

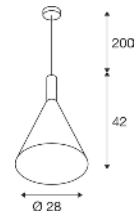

220-240 V ~50/60 Hz
Material: Aluminium

- Textilkabel



Socket: 1xE27

Variante	Art.Nr.	EUR
● schwarz/gold	1002950	187,00



E27 | 8 W | 320°
700 lm | 2500 K | EEK = F
8 kWh/1000h



Art.Nr.: 1005265 26,50 EUR



E27 | 7 W | 300°
640 lm | 2200-4000 K | EEK = G
7 kWh/1000h



Art.Nr.: 1010486 28,00 EUR

FORCHINI 50
PD, E27

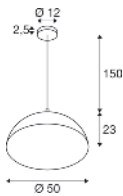

220-240 V ~50/60 Hz
Material: GFK



Socket: 1xE27 | L: 20 cm

Variante	Art.Nr.	EUR
●● schwarz/gold	1008535	228,00



E27 | 6 W | 330°
570 lm | 2200 K | EEK = F
6 kW/1000h



Art.Nr.: 1008153 54,00 EUR

FORCHINI 70
PD, E27

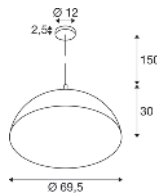

220-240 V ~50/60 Hz
Material: GFK



Socket: 1xE27 | L: 20 cm

Variante	Art.Nr.	EUR
●● schwarz/gold	1008538	403,00



E27 | 6 W | 330°
570 lm | 2200 K | EEK = F
6 kW/1000h



Art.Nr.: 1008156 54,00 EUR

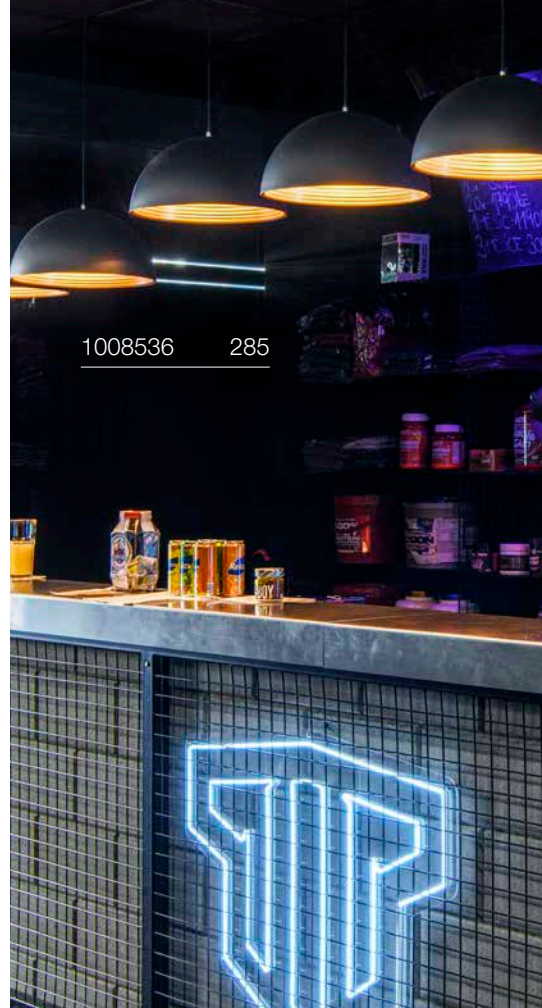

1008536 285



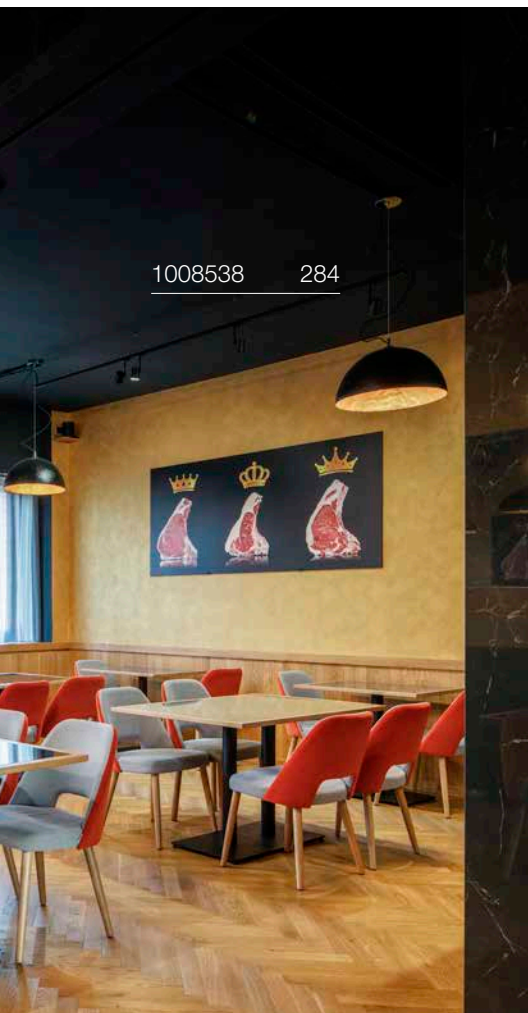

1008538 284



FORCHINI M 40

PD, E27

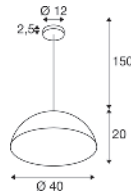

220-240 V ~50/60 Hz
Material: Stahl/Aluminium



Socket: 1xE27

L: 15,2 cm

Variante	Art.Nr.	EUR
●● schwarz/gold	1008536	228,00



E27 | 6 W | 330°
570 lm | 2200 K |
6 kW/1000h



Art.Nr.: 1008156 54,00 EUR

FORCHINI M 50

PD, E27

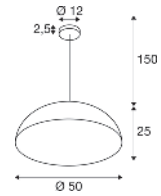

220-240 V ~50/60 Hz
Material: Stahl/Aluminium



Socket: 1xE27

L: 18 cm

Variante	Art.Nr.	EUR
●● schwarz/gold	1008537	251,00



E27 | 8 W | 330°
400 lm | 1900 K |
8 kW/1000h



Art.Nr.: 1008159 89,00 EUR



165410 287



165400 287

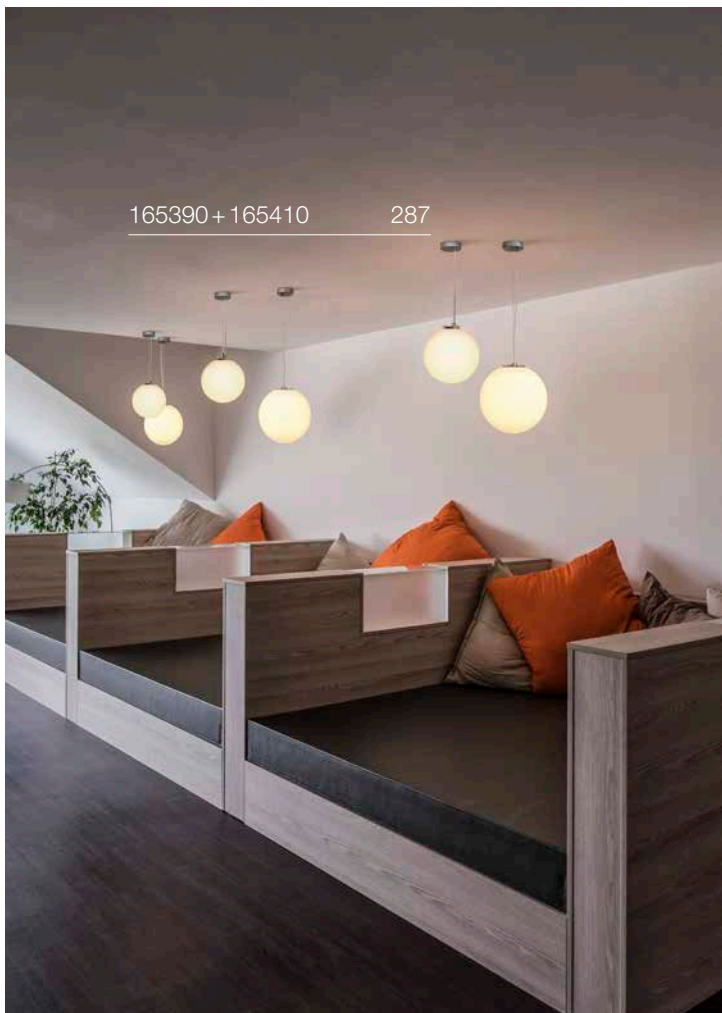

165390 + 165410 287



ROTOBALL 25

PD, E27

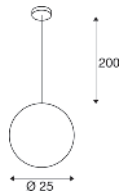

220-240 V ~50/60 Hz
Material: Stahl/Polyethylene (PE)

ROTOBALL 40

PD, E27

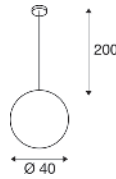

220-240 V ~50/60 Hz
Material: Stahl/Polyethylene (PE)

ROTOBALL 50

PD, E27

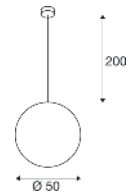

220-240 V ~50/60 Hz
Material: Stahl/Polyethylene (PE)



Socket: 1xE27 max. Ø: 7 cm

Variante	Art.Nr.	EUR
○ weiß	165390	161,00



Socket: 1xE27 max. Ø: 9,5 cm

Variante	Art.Nr.	EUR
○ weiß	165410	181,00



Socket: 1xE27 max. Ø: 9,5 cm

Variante	Art.Nr.	EUR
○ weiß	165400	222,00



E27 | 8 W | 320°
800 lm | 2700 K | EEK = F
8 kWh/1000h



Art.Nr.: 1005303 9,60 EUR



E27 | 13 W | 220°
1300 lm | 2700 K | EEK = F
14 kWh/1000h



Art.Nr.: 1005302 12,25 EUR



E27 | 8 W | 320°
800 lm | 2700 K | EEK = F
8 kWh/1000h



Art.Nr.: 1005303 9,60 EUR



E27 | 9,5 W | 190°
1100 lm | 2200-6500 K | EEK = F
10 kWh/1000h



Art.Nr.: 1010465 35,00 EUR

SYMBOLERKLÄRUNG



Empfehlungen
Zeigt Zubehör- und Leuchtmittelempfehlungen der jeweiligen Produkte

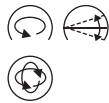

Dreh- und Schwenkbarkeit in Grad:

- Drehbereich
- Schwenkbereich
- Kardanisch



Kurzschlussfestes Sicherheitsbetriebsgerät

MIX
match

Mix & Match
Kennzeichnet individuell kombinierbare Produkte



Connected Lighting:

- Kennzeichnet smarte Produkte, die folgende Protokolle verwenden:
- Zigbee®
- DALI
- Bluetooth



Energieeffizienzklasse
„Diese Leuchte ist geeignet für Leuchtmittel der Energieeffizienzklassen ...“



Lichtstromerhalt:
Beschreibt, um wie viel der Lichtstrom einer LED im angegebenen Zeitraum abnimmt.



Erlaubt die Montage eines elektrischen Betriebsgeräts auf Werkstoffen, deren Entflammverhalten nicht bekannt ist.



Schutzklassen

- Schutzklasse I / Schutzleiter
- Schutzklasse II / Schutz durch doppelte oder verstärkte Isolierung
- Schutzklasse III / Schutz durch Kleinspannung



Unified Glare Rating:
Je niedriger der UGR-Wert, desto geringer die psychologische Blendung.



Pendelkabellänge
in cm



CCT-Schalter:
Mittels eingebautem CCT-Schalter kann die Lichtfarbe bei der Installation von 2700K, 3000K, 4000K auf 6500K gewechselt werden.

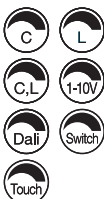

Dimmbar mit:

- C = Phasenabschnittsdimmer
- L = Phasenanschnittsdimmer
- Uni = Universaldimmer
- 1–10 V
- Dali = Dali Bussystem
- Switch = Schalter/Taster bzw. Touch Control an der Leuchte
- **Touch** = Einfache, stufenlose Bedienung; reagiert auf Berührung

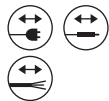

Kabellänge:
Netzsteckern, Konnektoren und Zuleitungen (bei offenem Kabelende) in cm



Durchverdrahtung möglich



Dim-to-Warm:
Durch das Dimmen verändert sich die Lichtfarbe von kaltweiß zu warmweiß.

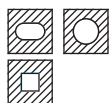

Form der Einbauöffnung



Kennzeichnet Leuchten mit RGB+W und RGB
(Rot-Grün-Blau + Weiß und Rot-Grün-Blau)



IP-Schutzart:
Gibt die Eignung elektrischer Betriebsmittel für verschiedene Umgebungsbedingungen an.



Angabe der Einbautiefe

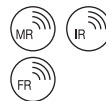

Kennzeichnet Leuchten mit Bewegungsmelder
(Mikrowellen (MR)-Technik / Infrarot / Funk)



IK-Stoßfestigkeitsgrad:
Der IK-Stoßfestigkeitsgrad ist ein Maß für die Widerstandsfähigkeit von Gehäusen elektrischer Betriebsmittel gegen mechanische Beanspruchung, insbesondere Stoßbeanspruchung.



Überfahrbarkeit des Produktes gegeben



Gewichtbelastbarkeit des Produkts bis zum angegebenen Wert in Tonnen. Messungen basieren auf Betoneinbau.



- Produkte mit eingebauten LEDs



- Produkte mit Lampenfassung



- Kennzeichnet smartes Zubehör und Leuchtmittel die mit SLVconnect® kompatibel sind



Halbstrahlwinkel:
Beschreibt den Ausstrahlungswinkel in Grad. Je kleiner der Winkel desto stärker wird das Licht gebündelt.



Seeluftbeständige Beschichtung



Unabhängiger Konverter:
Betriebsgerät auch zur Verwendung außerhalb von Leuchten

KS Licht- u. Elektrotechnik GmbH – für Sie vor Ort in Essen!



Link zum Multi-Brand Business Leuchten Onlineshop
unter www.business.KS-Licht.de

Ihre Business-Vorteile bei KS Licht erleichtern Ihnen die tägliche Arbeit.

Nutzen Sie unseren KS Multi-Brand Business Leuchten Onlineshop unter www.business.KS-Licht.de und profitieren Sie von folgenden Vorteilen und Funktionen:

- Aktuelle Sonderangebote und Neuheiten
- Onlineprüfung der Warenverfügbarkeit
- Alle Ersatzteile bequem finden und bestellen
- Schnellbestellformular zur schnellen Erfassung Ihres Auftrages
- Alle Kataloge zum Downloaden oder als Online-Blätterkatalog mit Produktlinks
- Ausschreibungstexte, Lichtverteilungskurven/LDT-Plugins und Schnellrechentabellen
- Einfache Produktsuche durch detaillierte Filterfunktionen
- Konfiguratoren für Leuchtensysteme
- Anzeige Ihrer individuellen Einkaufskonditionen, Liefer- und Zahlungsbedingungen
- Dropshipping-Lieferung direkt an Ihre Kunden (Erfassung der Lieferadressen online möglich)
- Passende Produktempfehlungen für Leuchtmittel, Zubehör, Treiber, EVGs u. ä.
- Anzeige von Alternativprodukten und Produktfamilien/Varianten
- Onlinechat mit unseren Beratern für Ihre Fragen
- Online-Archiv Ihrer bereits getätigten Onlinebestellungen
- Restpostenangebote zu Tiefstpreisen

Vertrauliche Kundeninformationen:

Alle Preise verstehen sich zuzüglich der gesetzlichen Mehrwertsteuer von zurzeit 19%.

Die angeführten Verkaufspreise sind Preisempfehlungen. Die Euro-Preise dienen als Kalkulationshilfe für den Fachhandel. Mit Erscheinen dieser Preisliste sind die Preise in allen bisher erschienenen Preislisten ungültig.

Unsere Leuchtenpreise verstehen sich grundsätzlich ohne Leuchtmittel es sei denn, die Produktbeschreibung weist auf die Lieferung incl. Leuchtmittel hin. Bestückungsangaben (Lampenleistung) beziehen sich auf Maximalwerte.

Die in diesem Katalog enthaltenen Abbildungen und Angaben dienen nur der Veranschaulichung und sind unverbindlich in Farbe, Form, Ausführung und technischen Daten.

Der Versand erfolgt generell unfrei ab Werk.

Sonderanfertigungen jeglicher Art, auf Kundenwunsch zusammengesetzte Komponenten unseres Lieferprogramms sowie Lampen sind vom Umtausch ausgeschlossen. Bei Bestellungen unter einem Bestellwert von 70,00 € wird ein Mindermengenzuschlag von 8,00 € berechnet.

Bei der Bestellung geben Sie bitte stets die Artikelnummer sowie Farbe und Stückzahl an. Dies erspart Rückfragen und Fehler.

Für eilige Bestellungen bieten wir Ihnen, Warenverfügbarkeit im Lager vorausgesetzt und Auftragseingang bis gegen 12.00 Uhr, folgende Lieferarten an:

- Over-Night-Lieferung bis 10.30 Uhr oder 12.00 Uhr in Deutschland mittels Express-Versand
- Lieferung am gleichen Tag mittels Direktfahrt zum Bestimmungsort

Über die Kosten geben wir Ihnen gerne im Einzelfall Auskunft.

Öffnungszeiten:

Montag - Donnerstag durchgehend von 08.00 Uhr bis 16.30 Uhr
Freitag durchgehend von 08.00 Uhr bis 15.00 Uhr

Während dieser Zeit erreichen Sie unser **Verkaufsteam** unter der Tel.-Nr. 0201-899 24-0
Für Ihre **Fax-Bestellung** steht Ihnen die Fax-Nummer 0201-899 24 124 zur Verfügung.
Per **Email** erreichen Sie uns unter Verkauf@KS-Germany.com.

Unsere **AGB** stellen wir Ihnen gerne auf Anfrage zur Verfügung. Sie finden diese auch auf der Rückseite unseres Anschreibens sowie **online** unter www.ks-germany.com/de/agb. Entgegenstehende Einkaufsbedingungen erkennen wir nicht an.

KS Licht- u. Elektrotechnik GmbH, Manderscheidstr. 8c, 45141 Essen

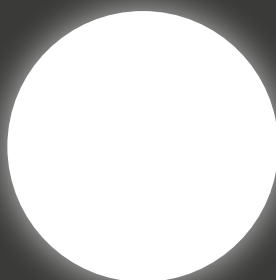

KS Licht- u. Elektrotechnik GmbH
Manderscheidtstr. 8c
45141 Essen

Tel.: +49 (0)201-89924-0

Fax: +49 (0)201-89924-124

Onlineshop: www.business.KS-Licht.de

Internet: www.KS-Germany.com

Email: Verkauf@KS-Germany.com

Besuchen Sie uns vor Ort oder rufen Sie uns an:

Montag - Donnerstag durchgehend von 08.00 Uhr bis 16.30 Uhr

Freitag durchgehend von 08.00 Uhr bis 15.00 Uhr

SOCIAL MEDIA

Bleiben Sie mit uns in Kontakt und up to date. Verpassen Sie keine News und Trends. Auf Facebook, YouTube, Instagram, Pinterest, X, Xing und LinkedIn finden Sie Interessantes, Neuigkeiten und viele Anregungen, wie Sie ihr Business mit der KS Licht Markenwelt ausbauen können.

Folgen Sie uns jetzt!

